

Model 212, 218 with transmission 722.97

Model 212.08/09/28/29, 218.36/39/99 with transmission 722.96

- 1 Rear engine crossmember
- 2 Bracket
- 3 Catalytic converter
- 6 Heat shield
- 20 Front axle transmission propeller shaft

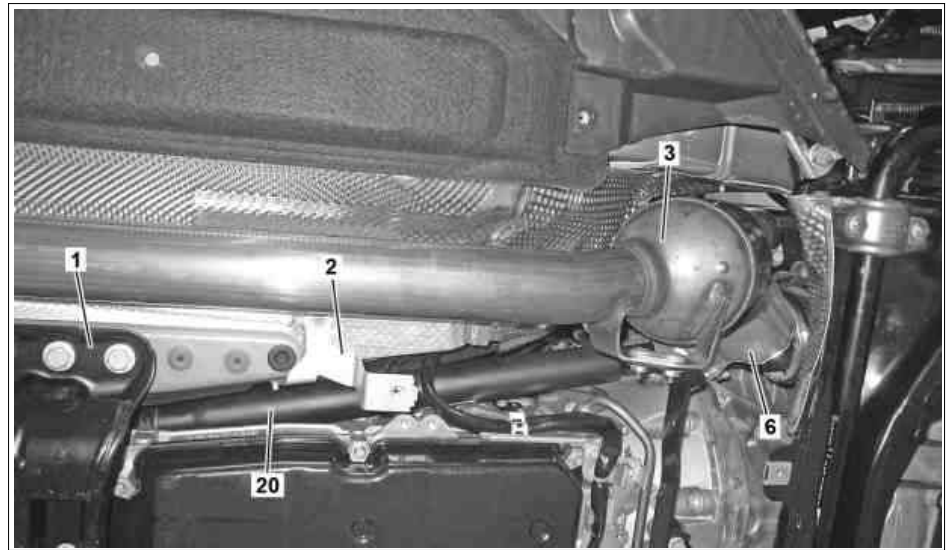

P41.10-2330-05

Shown on engine 273

- 10 Front axle gear
- 15 Transmission electrical line bracket
- 16 Screw
- 17 Retaining clamp for supply line
- 20 Front axle transmission propeller shaft
- 30 Cable duct bracket

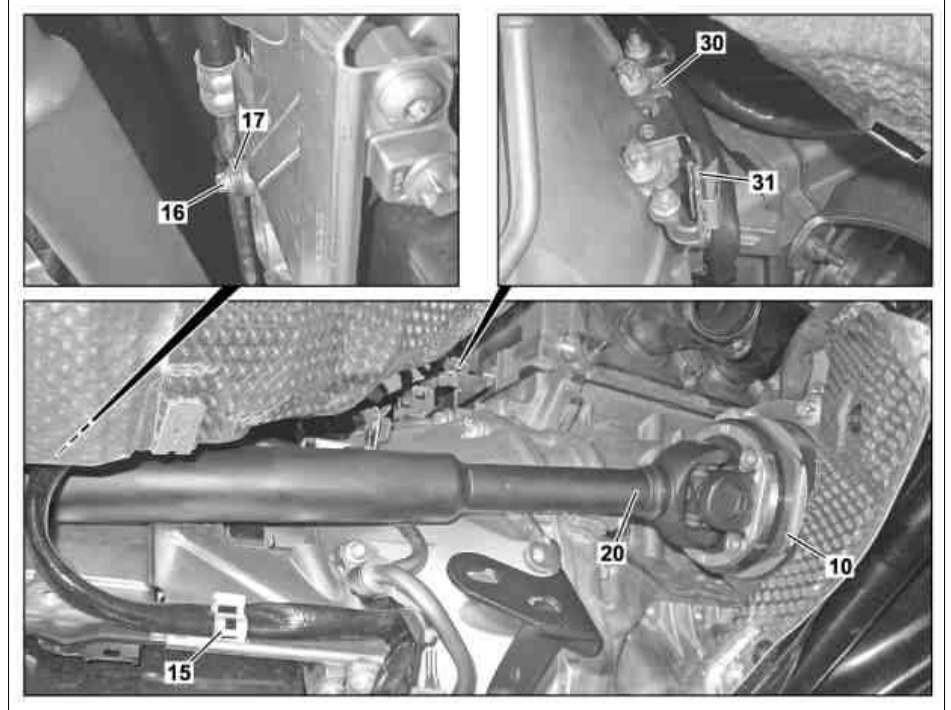

P41.10-2329-06

- 11 Splined profile for transfer case
- 12 Transfer case
- 13 Seal boot
- 20 Front axle transmission propeller shaft

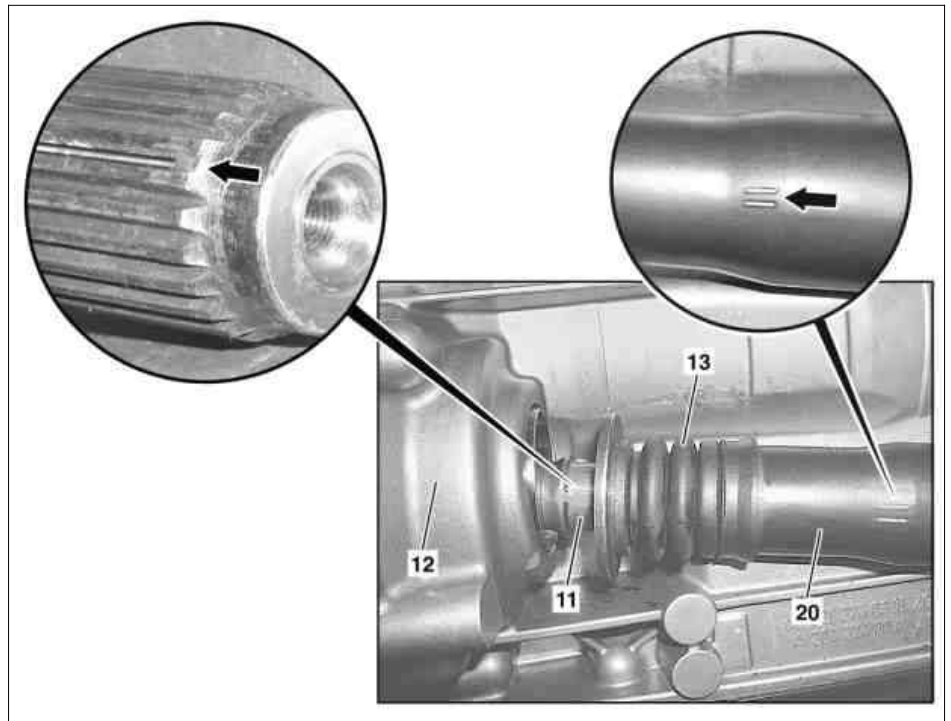

P41.20-2001-06





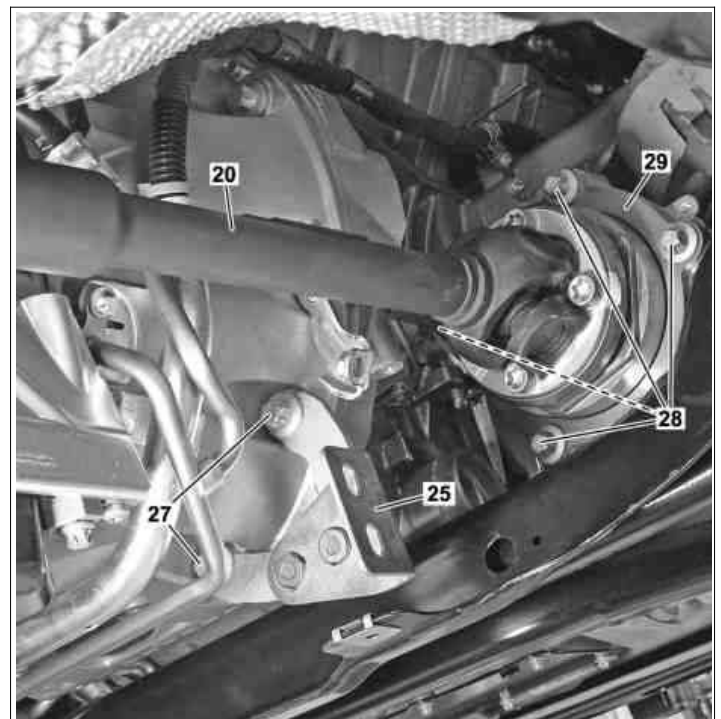









Shown on engine 642

- 20 Front axle transmission propeller shaft
- 25 Exhaust system bracket
- 27 Bolts
- 28 Bolts
- 29 Retaining ring



P41.10-2327-12

☒ ☒	Remove/install		
	Notes on self-locking nuts and bolts		AH00.00-N-0001-01A
1	Shift transmission to neutral		
2	Secure vehicle on vehicle lift		AR00.60-P-0100EWS
3.1	Remove bottom section of soundproofing	MODEL 212, 218 Vehicles with diesel engine	AR94.30-P-5300EW
3.2	Remove engine compartment paneling	MODEL 212, 218 Vehicles with gasoline engine	AR61.20-P-1105EW
4.1	Remove diesel particulate filter	MODEL 212, 218 with engine 642	AR14.40-P-1000OGE
4.2	Remove catalytic converter	Model 212 with engine 651	

			AR49.10-P-5500OMD
4.3	Remove right CAT with front connecting strut	Model 212 with engine 272, 273	AR49.10-P-7100EW
4.4	Remove right CAT together with center muffler	MODEL 212, 218 with engine 276, 278	AR49.10-P-7100EL
5	Remove heat shield (6)	 Collar bolt, heat shield to holder of heat shield/retaining plate  Collar bolt, holder for heat shield to transmission/holder for exhaust system	*BA33.30-P-1009-03G *BA33.30-P-1010-03G
6	Unscrew bolts (27) and remove exhaust system bracket (25) from transmission	 Bolt, automatic transmission to engine	*BA27.40-P-1008-01A
7	Remove bracket (2) of lower engine compartment paneling on frame floor assembly		
8	Remove propeller shaft at transmission		AR41.10-P-0050EW
9	Remove rear engine crossmember (1) from frame floor assembly		AR22.10-P-1180CW
10	Unclip transmission electrical line from transmission electrical line bracket (15)		
11	Lower transmission		
12	Remove bolt (16) to retaining clamp for supply line (17) on transmission	 Installation: Replace screw/bolt.  Bolt, oil line to transmission housing	*BA27.55-P-1002-01D
13	Mark position of front axle transmission propeller shaft (20) relative to flange of front axle transmission (10)	 To be able to reproduce the plant installation position.	
14	Detach front axle transmission propeller shaft (20) from front axle transmission (10)	 Do not counterhold front axle transmission drive shaft (20) on universal joint. The needle roller bearings and the seals of the front axle transmission drive shaft (20) may be damaged if not observed.  To undo the bolts of the front axle transmission propeller shaft (20) at the front axle transmission (10) the front wheels must be blocked.  Installation: Replace screw/bolts.  Screw/bolt, propeller shaft to front axle gear	*BA33.30-P-1012-03G
15	Remove front axle transmission drive shaft (20) from flange		
16	Unscrew bolts (28) and remove retaining collar (29)	Model 212, 218 with transmission 722.97 Model 212.09/29, 218.39/99 with engine 278 with transmission 722.96  Collar bolt, retaining plate to front axle differential	*BA33.30-P-1004-03G
17	Remove differential pressure sensor (DPF) bracket (B28/8)	Vehicles with diesel engine	
18	Detach front axle transmission propeller shaft (20) along engine from transfer case splined profile (11) on transfer case (12)	 Installation: Line up the marking (arrow in right enlarged detail in 3rd picture) on the front axle transmission propeller shaft (20) and the closed groove (arrow in left enlarged detail in 3rd picture) on the splined profile (11).	
19	Remove front axle transmission propeller shaft (20) downwards		
	Check		
20	Check seal boot (13) of front axle transmission propeller shaft (20)	 If necessary, replace seal boot (13).	
21	Check constant velocity joint and double cardan U-joint of front axle transmission propeller shaft (20) for signs of wear and damage	 If necessary, replace front axle transmission propeller shaft (20).	
22	Install in the reverse order		

 **Housing**

Number	Designation	Transmission 722.9		
BA27.40-P-1008-01A	Bolt, automatic transmission to engine	M10×40	Nm	38
		M10×45	Nm	38
		M10×90	Nm	38

	M12	Nm	-
--	-----	----	---

Nm Oil cooling

Number	Designation	Transmission 722.9
BA27.55-P-1002-01D	Bolt, oil line to transmission housing	Banjo bolt Stage 1 Nm 5
		Stage 2 Δ° 90
	Hexalobular bolt Nm 12	

Nm Front axle gear

Number	Designation		Model 212	Model 218
BA33.30-P-1004-03G	Collar bolt, retaining plate to front axle differential	Nm	55	55

Nm Front axle gear

Number	Designation		Model 212	Model 218
BA33.30-P-1009-03G	Collar bolt, heat shield to holder of heat shield/retaining plate	Nm	8	8

Nm Front axle gear

Number	Designation		Model 212	Model 218
BA33.30-P-1010-03G	Collar bolt, holder for heat shield to transmission/holder for exhaust system	Nm	8	12

Nm Front axle gear

Number	Designation		Model 212	Model 218
BA33.30-P-1012-03G	Screw/bolt, propeller shaft to front axle gear	Stage 1 Nm 45	45	
		Stage 2 Δ° 95	95	