

- Parts list -

Vehicle	WDDHF7GB5FB156149 (D04)	Mercedes-AMG E 63 S 4MATIC Sedan
Color	799 - Diamond white - Metallic finish	Equipment 821 - Leather/nappa/semi-aniline - black/anthracite
FIN: WDD2120761B156149		Assortment class PC
Group	01 ENGINE HOUSING	Sub-group 060 CYLINDER HEAD

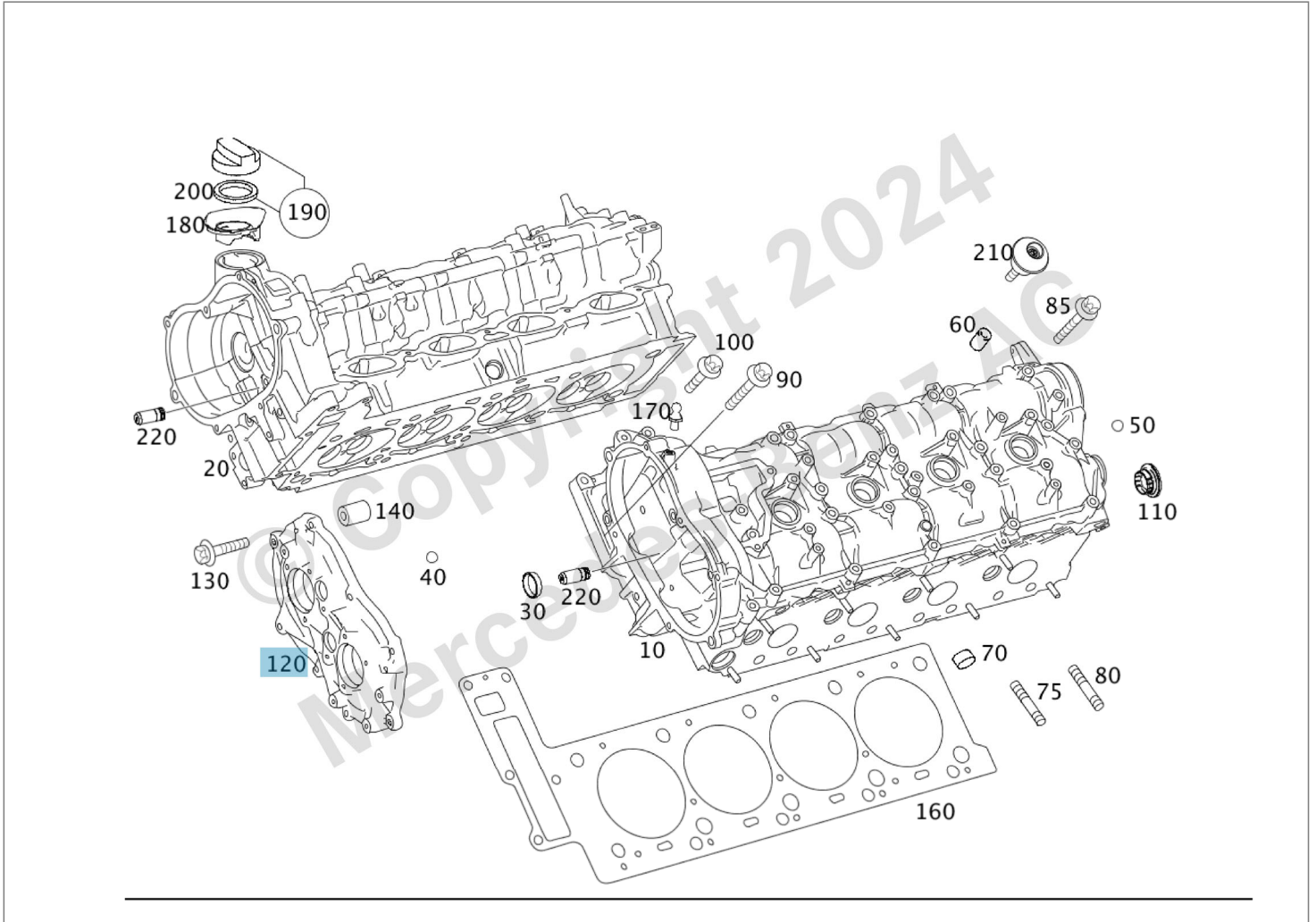

























Image ID: drawing\_B01060000340

Item	Part number	Designation/additional information	Qty
10	A 278 010 75 20	CYLINDER HEAD Left Replaced by: A 157 010 59 00 +1 A 278 050 33 00 CHECK VALVE	1
10	A 157 010 59 00 ↔	CYLINDER HEAD Left, without valve [697] PART IS ONLY OR ALSO SUPPLIED AS RECONDITIONED PART	1





## Parts Information

Item	Part number	Designation/additional information	Qty
		Replaces: A 278 010 75 20	
20	A 278 010 76 20 	CYLINDER HEAD Right Replaced by: A 157 010 60 00 +1 A 278 050 33 00 CHECK VALVE	1
20	A 157 010 60 00  	CYLINDER HEAD Right, without valve  [697] PART IS ONLY OR ALSO SUPPLIED AS RECONDITIONED PART Replaces: A 278 010 76 20	1
30	N 000000 006531  	* CAP Plug for coolant bores	5
30	N 000000 006531 	* CAP Plug for coolant bores	1
40	N 005401 308000 	* BALL Inner chain case oil duct plug 8 MM	2
40	N 005401 308000 	* BALL Chain case oil duct plug 8 MM	1
50	N 005401 308000 	* BALL Rear oil duct plug	2
50	N 005401 304000 	* BALL Rear oil duct 4 MM	3
50	N 005401 308000 	* BALL Chain case oil duct plug 8 MM	2
50	N 005401 308000 	* BALL Rear oil duct 8 MM	2
60	N 000000 002507 	* CYLINDER PIN Cylinder head cover to cylinder head, right	2
60	N 000000 002507 	* CYLINDER PIN Cylinder head cover to cylinder head, left	2
70	N 000000 006531  	* CAP Exhaust water jacket plug	4

## Parts Information

Item	Part number	Designation/additional information	Qty
70	N 000000 006531  	* CAP Intake water jacket plug	1
70	N 000000 006531 	* CAP Water jacket and air duct cap <a href="#">Replaces: N 000000 004125</a>	2
70	N 000000 004125 	* CAP Water jacket and air duct cap <a href="#">Replaced by: N 000000 006531</a>	2
75	A 000 990 54 16 	* THREADED PIN Exhaust manifold mount, left and right	13
80	A 002 990 09 14 	* STUD BOLT Turbocharger mount	6
85	A 113 990 02 22	HEXALOBULAR HEAD SCREW Right cylinder head cover to cylinder head; M7X45	21
85	A 113 990 02 22	HEXALOBULAR HEAD SCREW Left cylinder head cover to cylinder head; M7X45	21
90	A 278 016 01 69	CYLINDER HEAD BOLT Cylinder head to cylinder crankcase	20
100	A 001 990 81 22	RIVET SCREW Right cylinder head to timing case chain case; M7X85	1
100	A 002 990 99 22	HEXALOBULAR HEAD SCREW Right cylinder head to timing case; M7X100	1
100	A 001 990 90 22	HEXALOBULAR HEAD SCREW Right cylinder head to timing case chain case	2
100	A 001 990 81 22	RIVET SCREW Left cylinder head to timing case chain case; M7X85	1
100	A 002 990 99 22	HEXALOBULAR HEAD SCREW Left cylinder head to timing case; M7X100	1
100	A 001 990 90 22	HEXALOBULAR HEAD SCREW Left cylinder head to timing case chain case M7X25	2

## Parts Information

Item	Part number	Designation/additional information	Qty
110	A 000 998 65 90 	CLOSING CAP Rear cylinder head	1
120	A 276 015 02 01	CHAIN CASE COVER Front right	1
120	A 276 015 02 01	CHAIN CASE COVER Left front	1
130	N 000000 006365	HEXALOBULAR BOLT Right box cover to cylinder head; M6X16	8
130	N 000000 006365	HEXALOBULAR BOLT Left box cover to cylinder head; M6X16	8
140	A 668 992 00 25	SLEEVE Box cover mount	4
160	A 278 016 07 20	CYLINDER HEAD GASKET Right	1
160	A 278 016 03 25	CYLINDER HEAD GASKET Left	1
170	A 642 016 00 74	PIN Cover to right cylinder head cover	1
170	A 642 016 00 74	PIN Cover to left cylinder head cover	1
180	A 278 018 00 80	ELASTOMERIC MOLDED SEAL To cylinder head cover filler cap	1
190	A 000 010 03 01 	FILLER CAP Cylinder head cover oil filler plug, right	1
200	A 111 018 00 80 	* GASKET Oil replenishment cap	1
210	A 112 090 00 89	BEARING Damper filter to cylinder head cover  [402] NO LONGER AVAILABLE	4
220	A 278 050 40 00	CHECK VALVE Chain tensioner, only for cylinder head without stepped bore	2

Parts Information

Item	Part number	Designation/additional information	Qty
220	A 278 050 33 00	CHECK VALVE Chain tensioner, only for cylinder head with stepped bore	2