

- Parts list -

Vehicle	WDDHF7GB5FB156149 (D04)	Mercedes-AMG E 63 S 4MATIC Sedan
Color	799 - Diamond white - Metallic finish	Equipment
FIN: WDD2120761B156149		821 - Leather/nappa/semi-aniline - black/anthracite
Group	52 Chassis sheet metal parts / air intake	Assortment class
		Sub-group
		PC
		140 Gasoline vehicle air intake

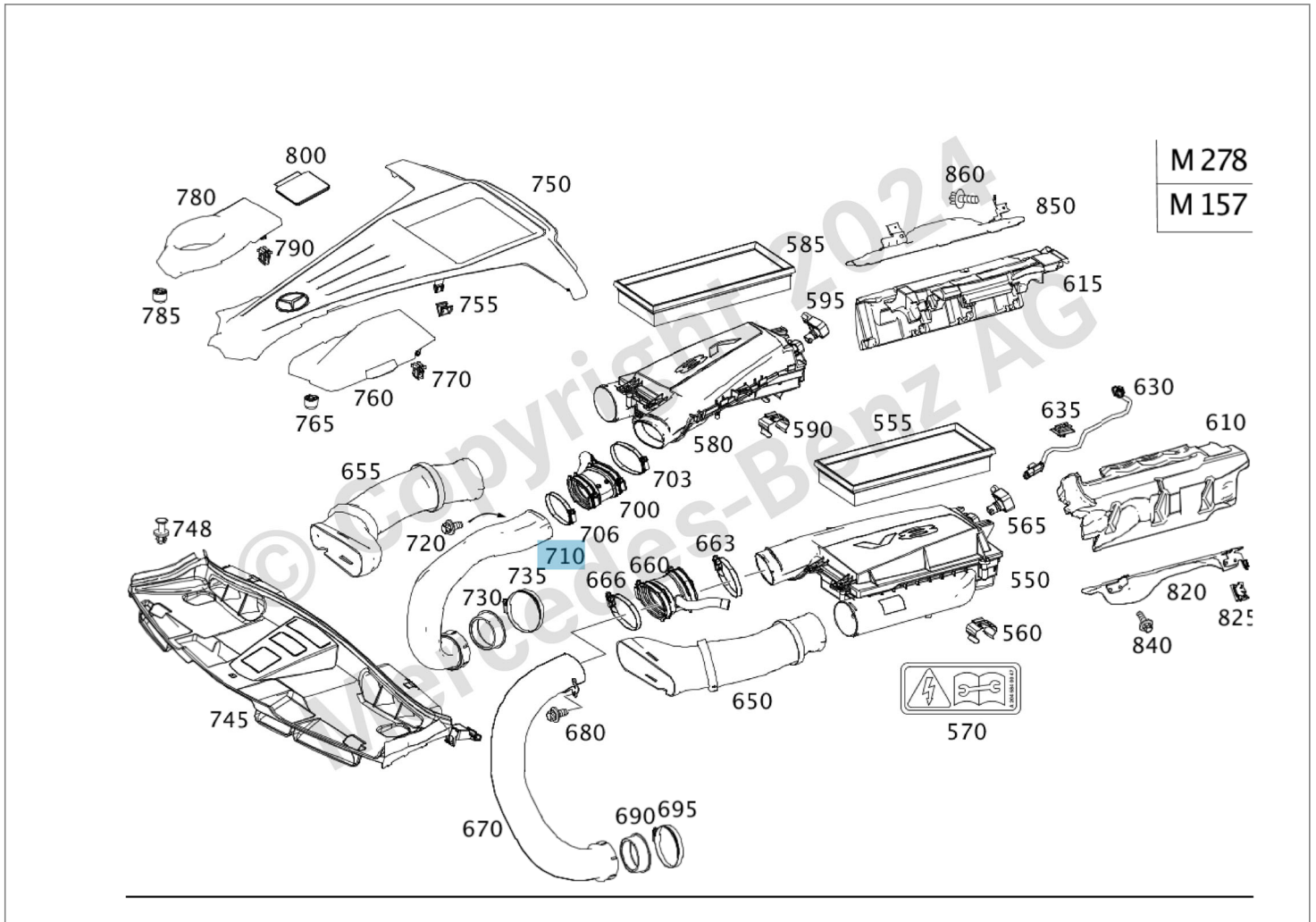





































Image ID: drawing_B52140000140

Item	Part number	Designation/additional information	Qty
55	A 000 991 95 40	EXPANSION RIVET Cover mount Code: (804/805/806/807);	2
245	A 000 991 95 40	EXPANSION RIVET Cover mount	2













Parts Information

Item	Part number	Designation/additional information	Qty
		 Code: (804/805/806/807);	
330	A 000 991 95 40	EXPANSION RIVET Cover mount  Code: (804/805/806/807);	2
550	A 278 090 21 01 	DAMPING AIR FILTER AIR FILTER HOUSING LEFT  Code: M157+M55;	1
555	A 278 094 00 04  	* AIR FILTER ELEMENT LEFT  Code: M278/M157;	1
560	A 112 094 00 41 	* HOLDER AIR FILTER HOUSING FASTENING  Code: M278/M157;	2
565	A 000 905 59 06 	* PRESSURE SENSOR TO REAR AIR FILTER HOUSING  Code: M157;	1
570	A 204 584 00 47 	* WARNING STRIPES TO AIR FILTER HOUSING LEFT  Code: M278/M157;	1
580	A 278 090 24 01 	DAMPING AIR FILTER AIR FILTER HOUSING RIGHT  Code: M157+M55;	1
585	A 278 094 00 04  	* AIR FILTER ELEMENT RIGHT  Code: M278/M157;	1
590	A 112 094 00 41 	* HOLDER AIR FILTER HOUSING FASTENING  Code: M278/M157;	2
595	A 000 905 59 06 	* PRESSURE SENSOR TO REAR AIR FILTER HOUSING  Code: M157;	1
610	A 278 226 21 85	NOISE INSULATION BETWEEN LEFT AIR FILTER AND CYLINDER HEAD COVER  [402] NO LONGER AVAILABLE	1























Parts Information

Item	Part number	Designation/additional information	Qty
		 Code: M278/M157;	
615	A 278 226 20 85	NOISE INSULATION BETWEEN RIGHT AIR FILTER AND CYLINDER HEAD COVER  Code: M278/M157;	1
630	A 278 150 60 20	ENGINE WIRING HARNESS ADAPTER LINE TO PRESSURE SENSOR  Code: M278/M157;	1
635	A 002 545 18 40	HOLDER CABLE HARNESS MOUNTING  Code: M278/M157;	1
650	A 278 090 51 82	AIR INTAKE HOSE LEFT  Code: M157/M278;	1
655	A 278 090 20 82	AIR INTAKE HOSE RIGHT  Code: M278/M157;	1
660	A 278 094 08 91 	BOOT LEFT  Code: M278/M157;	1
663	A 001 995 47 10 	* HOSE CLAMP W WORM DRIVE BOOT TO AIR FILTER HOUSING  Code: (M278/M157);	1
666	A 001 995 46 10 	* HOSE CLAMP W WORM DRIVE BOOT TO CLEAN AIR LINE  Code: (M278/M157);	1
670	A 278 094 09 97	CLEAN AIR LINE LEFT  Code: M157+M55;	1
680	N 910143 006000	HEXALOBULAR BOLT CLEAN AIR LINE TO CYLINDER HEAD COVER; M6X12  Code: M278+M46/M157;	1
690	A 266 141 01 60	SEALING RING CLEAN AIR LINE AT CHARGER	1





Parts Information

Item	Part number	Designation/additional information	Qty
		 Code: M278+M46/M157;	
695	A 006 997 27 90	HOSE CLAMP W. WORM DRIVE CLEAN AIR LINE AT CHARGER; 60-80 MM  Code: M278+M46/M157;	1
700	A 278 094 09 91 	BOOT RIGHT WITHOUT VENT LINE  Code: M278/M157;	1
700	A 278 094 13 91 	BOOT RIGHT WITH VENT LINE  Code: (M278/M157);	1
703	A 001 995 47 10 	* HOSE CLAMP W WORM DRIVE BOOT TO AIR FILTER HOUSING  Code: (M278/M157);	1
706	A 001 995 46 10 	* HOSE CLAMP W WORM DRIVE BOOT TO CLEAN AIR LINE  Code: (M278/M157);	1
710	A 278 094 06 97	CLEAN AIR LINE RIGHT  Code: M157+M55;	1
720	N 910143 006000	HEXALOBULAR BOLT CLEAN AIR LINE TO CYLINDER HEAD COVER; M6X12  Code: M278+M46/M157;	1
730	A 266 141 01 60	SEALING RING CLEAN AIR LINE AT CHARGER  Code: M278+M46/M157;	1
735	A 006 997 27 90	HOSE CLAMP W. WORM DRIVE CLEAN AIR LINE AT CHARGER; 60-80 MM  Code: M278+M46/M157;	1
745	A 212 500 04 55	COLD AIR INTAKE TOP  Code: (M278/M157)+(804/805/806/807);	1
748	A 000 991 95 40	EXPANSION RIVET Cover mount	2

Parts Information

Item	Part number	Designation/additional information	Qty
		 Code: (804/805/806/807);	
750	A 157 010 37 00 	ENGINE COVER  Code: M157+M55;	1
755	A 003 991 51 70 	* FASTENING CLIP FRONT  Code: M157+M55;	4
755	A 094 994 65 00 	* FASTENING CLIP REAR  Code: M157+M55;	2
760	A 278 010 08 67 	COVER LEFT  Code: M157+M55;	1
765	A 156 094 00 85 	* RUBBER BUMPER FASTENING, FRONT COVER  Code: M157+M55;	1
770	A 003 991 82 70 	* FASTENING CLIP FASTENING, REAR COVER  Code: M157+M55;	2
780	A 278 010 07 67 	COVER RIGHT  Code: M157+M55;	1
785	A 156 094 00 85 	* RUBBER BUMPER FASTENING, FRONT COVER  Code: M157+M55;	1
790	A 003 991 82 70 	* FASTENING CLIP FASTENING, REAR COVER  Code: M157+M55;	2
800	A 000 221 24 01	ENGINE LABEL IN COVER, CENTER  Code: M157+M55;	1
820	A 278 094 49 20 	SCREENING PLATE ON LEFT CYLINDER HEAD  Code: M278/M157;	1

Parts Information

Item	Part number	Designation/additional information	Qty
825	A 000 991 02 71	CLAMP TO SHIELD; 18X19 MM  Code: M278/M157;	1
840	N 000000 001145	HEXALOBULAR BOLT SCREENING PLATE TO CYLINDER HEAD; M6X12  Code: M278/M157;	2
850	A 278 094 07 20	SCREENING PLATE ON RIGHT CYLINDER HEAD  Code: M278/M157;	1
860	N 910143 006000	HEXALOBULAR BOLT SCREENING PLATE TO CYLINDER HEAD; M6X12  Code: M278/M157;	2