

Parts Information

- Parts list -

Vehicle	WDD2120771A068092 (D02)	E 63 AMG Sedan	
Color	197 - Obsidian black - Metallic finish	Equipment	808 - Leather/nappa/semi-aniline - gray
Assortment class	PC	Group	46 Steering
Sub-group	015 Steering gear		

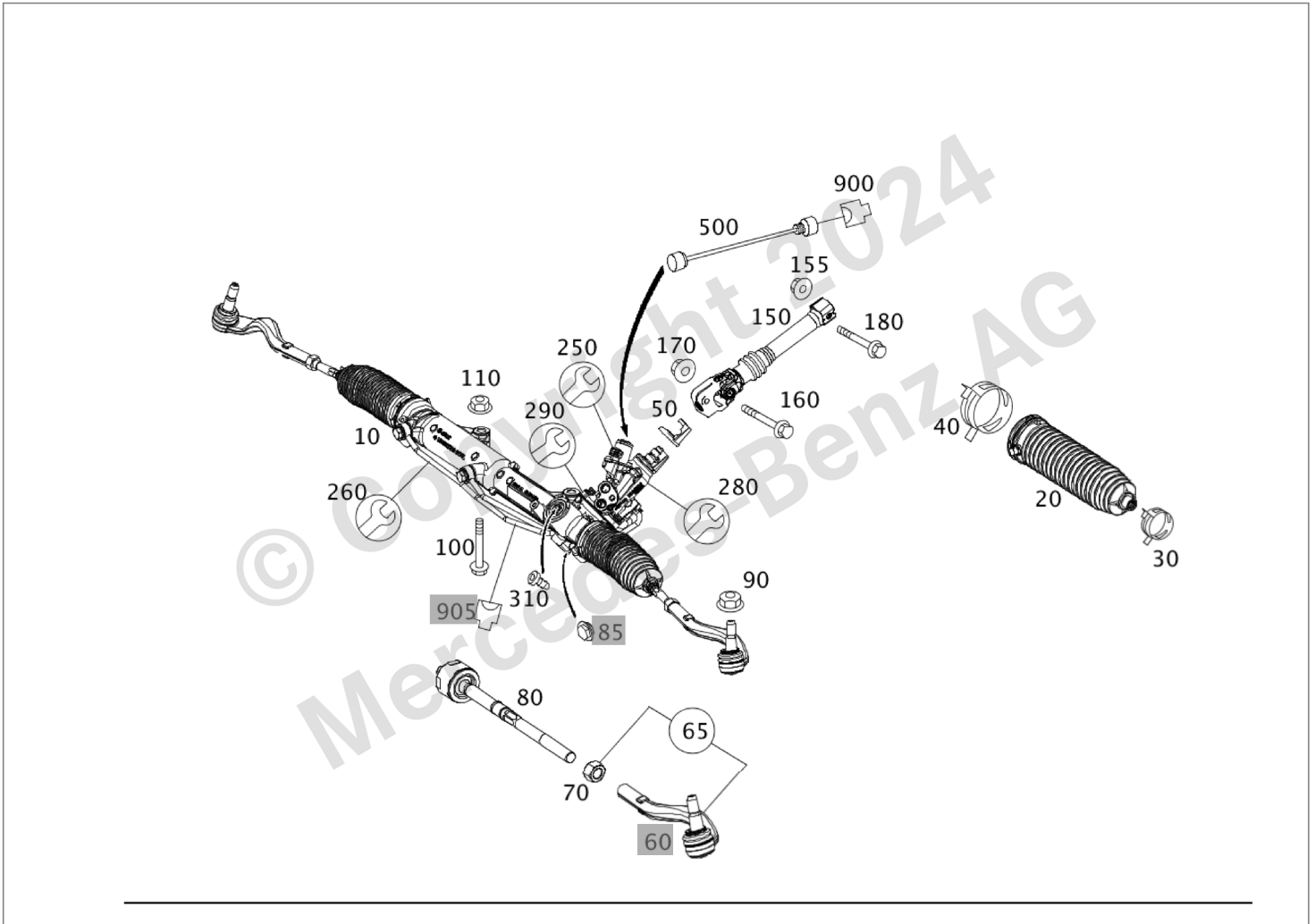



















Image ID: drawing\_B46015000084

Item	Part number	Designation/additional information	Qty
10	A 212 460 23 00 	STEERING [697] PART IS ONLY OR ALSO SUPPLIED AS RECONDITIONED PART Code: M156+(M63/M63+(494/460))+213;	1
20	A 204 463 02 96 	* BOOT Code: -(M005/211);	2

## Parts Information

Item	Part number	Designation/additional information	Qty
30	A 210 463 08 17 	* CLAMP OUTSIDE; 15.2-18.5 MM  Code: -(M005/M157);	2
40	A 210 463 07 17 	* CLAMPING PIECE INSIDE; 68 MM  Code: -(M005/M157/211);	2
50	A 212 462 01 57  	* PROT. CAP, STEERING GEAR  Code: -M005;	1
65	A 212 330 25 03  	* TIE ROD LEFT OUTSIDE  Code: M156+M63;	1
65	A 212 330 26 03  	* TIE ROD RIGHT OUTSIDE  Code: M156+M63;	1
70	N 308673 014001  	** HEXAGON NUT LEFT AND RIGHT; M14X1.5  Code: (M156+M63/M157+M55);	2
80	A 212 330 21 03 	* TIE ROD INSIDE LEFT AND RIGHT  Code: 213+-(M005/M157);	2
90	N 000000 003281	HEXAGON NUT TIE ROD TO STEERING KNUCKLE; M14X1,5  [414] THE OLD PART MUST NO LONGER BE INSTALLED Replaced by: N 000000 008261	2
90	N 000000 008261	HEXAGON NUT TIE ROD TO STEERING KNUCKLE; M14X1.5 Replaces: N 000000 003281	2
100	A 015 990 92 01	HEXAGONAL HEAD SCREW STEERING TO REAR FRAME-TYPE INTEGRAL SUPPORT; M12X70  Code: -M005;	2
110	N 913023 012002 	NUT STEERING TO REAR FRAME-TYPE INTEGRAL SUPPORT; M12X1.5  Code: -211;	2

## Parts Information

Item	Part number	Designation/additional information	Qty
150	A 204 462 02 78  	STEERING COUPLING  Code: (M156/M272/M273/M276/M278/M157)+-M005;	1
155	A 140 990 09 58  	* HEXAGON NUT STEERING COUPLING TO BOTTOM STEERING SHAFT; M8	1
160	A 210 990 06 04 	SCREW STEERING COUPLING TO STEERING GEAR; M8X39	1
170	A 140 990 09 58 	HEXAGON NUT STEERING COUPLING TO STEERING GEAR; M8	1
180	N 910105 008014	HEXAGON HEAD BOLT STEERING COUPLING TO BOTTOM STEERING SHAFT; M8X35	1
250	A 221 460 01 84	REPAIR KIT, VALVE REPAIR KIT  Code: -(M005/211);	1
260	A 212 460 48 00 	REPAIR KIT, STEERING GEAR REPAIR KIT FOR OIL LINES  Code: -(M005/211);	1
280	A 212 460 88 00 	REPAIR KIT, STEERING GEAR CONTROL HEAD REPAIR KIT  Code: 213+-(M005/211/494/460);	1
290	A 204 460 00 61	REPAIR KIT, SEALING RING AT CONTROL HEAD  Code: -M005;	1
310	A 210 988 01 28	GROMMET	1
500	A 212 540 18 09  	ELECTRICAL WIRING HARNESS SPEED-SENSITIVE POWER STEERING ADAP.  Code: 213+-(M005/211);	1
900	A 005 540 33 81	PIN HOUSING SPEED-SENSITIVE POWER STEERING CONN. X18/33; 2-PIN MQS  Code: 213;	1