

Parts Information

- Parts list -

| | | | |
|------------------|---|----------------|---|
| Vehicle | WDD2120771A068092 (D02) | E 63 AMG Sedan | |
| Color | 197 - Obsidian black - Metallic finish | Equipment | 808 - Leather/nappa/semi-aniline - gray |
| Assortment class | PC | Group | 46 Steering |
| Sub-group | 075 Steering column tube and steering shaft | | |

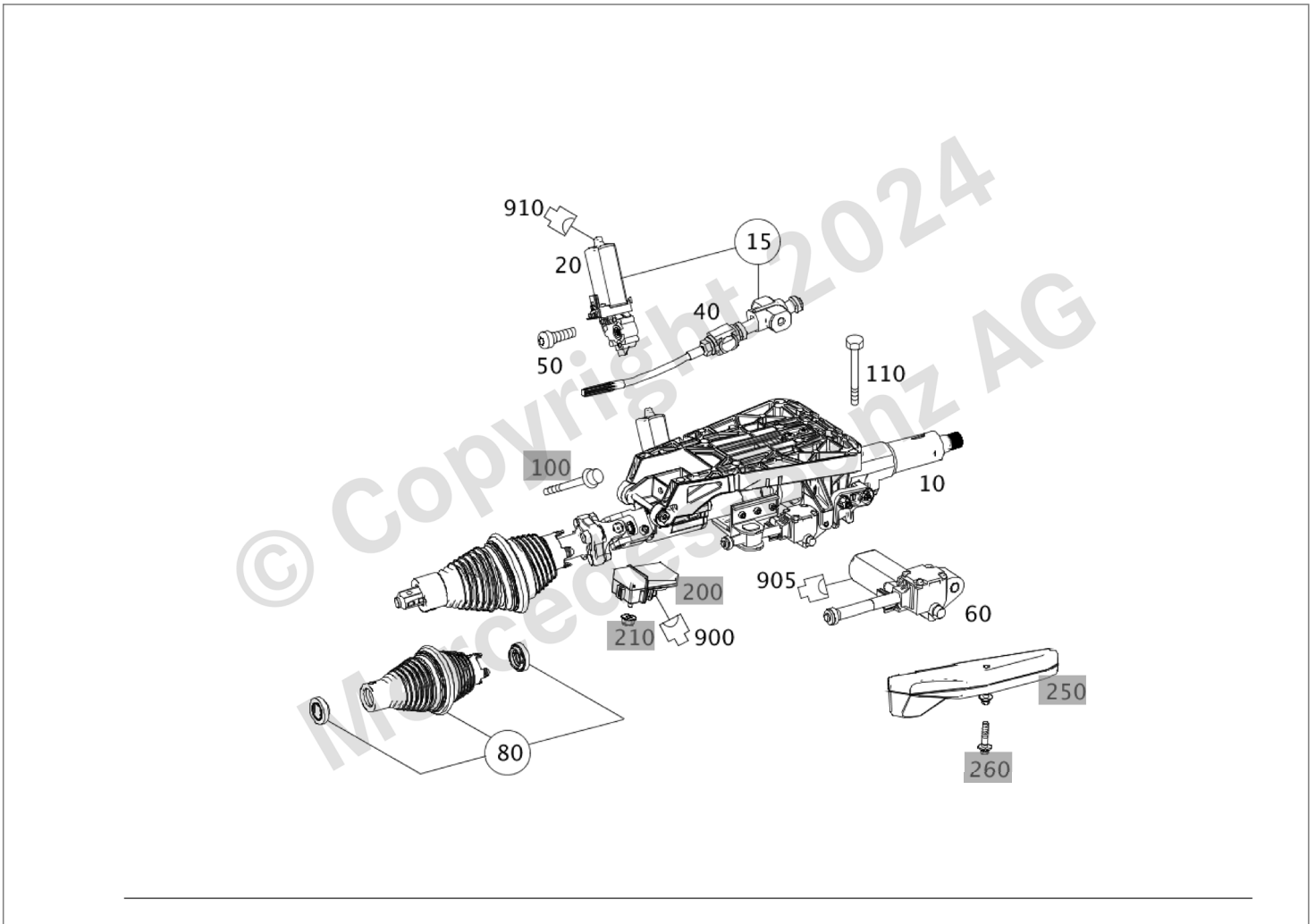

















Image ID: drawing_B46075000116

| Item | Part number | Designation/additional information | Qty |
|------|---------------------|---|-----|
| 10 | A 212 460 20 16 | STEERING COLUMN COMPLETE Code: M156+M63+275; Replaced by: A 212 460 26 16 Replaced by: A 212 460 46 16 | 1 |

Parts Information

| Item | Part number | Designation/additional information | Qty |
|------|--|--|-----|
| 10 | A 212 460 26 16  | STEERING COLUMN COMPLETE  Code: M156+M63+275/((M157+M55+-M005)+275)+(802/803); Replaced by: A 212 460 46 16 Replaces: A 212 460 20 16 | 1 |
| 10 | A 212 460 46 16  | STEERING COLUMN COMPLETE  [004006, 004008] ATTENTION: OBSERVE SI46.10-P-0010A  Code: M156+M63+275/((M157+M55+-M005)+275)+(802/803); Replaces: A 212 460 20 16 Replaces: A 212 460 26 16 | 1 |
| 15 | A 204 460 08 25   | * PARTS KIT, GEAR MOTOR PARTS KIT  [001176] OBSERVE WIS | 1 |
| 20 | A 204 460 00 25  | ** TRANSMISSION HEIGHT ADJUSTMENT | 1 |
| 40 | A 204 462 00 13  | ** SHAFT, STEPPED HEIGHT ADJUSTMENT | 1 |
| 50 | A 002 984 29 29  | * SCREW FASTENING, GEAR HEIGHT ADJUSTMENT; M5 X 18 MM | 2 |
| 60 | A 204 460 01 25  | * PARTS KIT, GEAR MOTOR FORE-AND-AFT ADJUSTMENT  [417] IS NO LONGER DELIVERED, ORDER DELIVERY CONTENTS | 1 |
| 80 | A 204 460 02 96  | * REPAIR KIT, BOOT STEERING SHAFT, BOTTOM | 1 |
| 110 | N 910105 008019 | HEXAGON HEAD BOLT STEERING COLUMN TO CARRIER; M8X50 | 2 |
| 110 | N 910143 008009  | HEXALOBULAR BOLT STEERING COLUMN TO CARRIER; M8X70 | 2 |
| 900 | A 210 545 87 28 | COUPLING, MECHANICAL CONTROL MODULE POWER STEERING LOCK N26/5*1; 4-PIN JPT | 1 |
| 905 | A 221 545 10 26 | PLUG HOUSING STEERING COLUMN LENGTH ADJUSTMENT MOTOR M20/1; 4-PIN JPT, MT3 | 1 |

Parts Information

| Item | Part number | Designation/additional information | Qty |
|------|-----------------|---|-----|
| 910 | A 221 545 10 26 | PLUG HOUSING STEERING COLUMN HEIGHT ADJUSTMENT MOTOR M20/2; 4-PIN JPT, MT3 | 1 |