

E-Class Wagon



Model Year 2018

Preliminary – Subject to change

Mercedes-Benz
The best or nothing.





Important note

The information presented in this guide is based on the most current information available and is intended for internal use only. Mercedes-Benz reserves the right to make changes at any time, without notice, to colors, materials, equipment, special specifications and models.

Pricing may not yet be finalized for some models or options.

Due to variances among monitors and printers the colors that appear on your screen and printouts may not be exact.

For illustrative purposes, some images may show vehicles with European Specification.

Revision History

<i>Date</i>	<i>Changes</i>
02/24/17	Initial release
02/03/17	<i>designo</i> Packages (P62, P87) require Premium Packages (P01, P02, P03)
03/08/17	Updated ADAS nomenclature
03/28/17	Added the AMG E63 S variant



E400 4MATIC



Models



Interior Trims



What's new



Option Packages



Standard Equipment



Stand-Alone Options

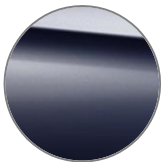

Exterior Paint Colors



Options in Detail



Wheels

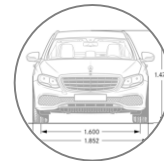

Specifications



Interior Upholstery



E400 4MATIC (213.266)

- MSRP \$tba
- 3.0L V6 biturbo engine
- 329 hp
- 354 lb-ft
- Launch date: Summer 2017





Exterior Comparison AMG Line Exterior (322) and Luxury Line (167)





Exterior Comparison AMG Line Exterior (322) and Luxury Line (167)





AMG Line Exterior (322)



AMG Line Exterior (322)

Requires Sport Styling (321)

Option Price: \$500

The package includes:

- 51U – Black headliner
- Wheel Choice of:
 - RQR – 18" AMG 5-Spoke Wheels with all-season, run-flat tires
 - RTK – 19" AMG Twin 5-Spoke Wheels with all-season, run-flat tires (+\$500)



18" AMG
5-Spoke Wheel



19" AMG Twin
5-Spoke Wheel



Rear Seat Entertainment and Comfort Adapter (866)



Rear Seat Entertainment and Comfort Adapter (866)

Option price: \$tba

The new code 866 is a slot in the backrest of the front driver and passenger seats with a plug-in adapter. Several rear seat entertainment and comfort accessories work in conjunction with this adapter. Accessories must be purchased separately.

IMPORTANT NOTE:

Please do not confuse the existing equipment "Pre-Installation Rear Seat Entertainment" with this equipment as they have the same code.





Interior

- Natural Grain Black Ash Wood and Natural Grain Brown ash wood trim w/ matching center console

Standard Equipment

- Rearview camera

Optional Equipment

- 3-Zone climate control
- Active Multicontour Seats w/ massage function
- New Premium Package content
- Night Package
- Rear Seat Entertainment and Comfort Adapter
- Soft-Close doors
- Illuminated door sills with “Mercedes-Benz” lettering



Performance & Handling

- 9G-TRONIC 9-Speed Automatic Transmission
- 3.0L V6 biturbo engine (329 hp, 354 lb-ft)
- DYNAMIC SELECT driving programs

Comfort & Convenience

- Ambient Lighting (64 colors)
- Auto-Dimming Driver-Side and Rearview Mirrors
- Bluetooth® Connectivity
- COMAND® Navigation System
- Garage door opener
- KEYLESS-START
- Powered front seats w/ 3-position memory and 4-way lumbar support
- Power Folding Mirrors
- Power Liftgate
- Power Tilt/Sliding Sunroof
- Rearview camera
- Smartphone integration with Apple CarPlay™ & Android Auto
- Split folding rear seats (40/20/40)
- Steering wheel with Touch Control Buttons
- Touchpad w/ central controller
- 12.3" COMAND display
- Folding Rear-Facing 3rd Row Seats
- 5 Years of mbrace® Connect

Safety & Security

- Active Brake Assist
- ATTENTION ASSIST®
- Car-to-X Communication
- Crosswind Assist
- LED headlamps
- PRE-SAFE®
- PRE-SAFE® Sound
- Tire pressure monitoring system

Exterior Paint Colors



Non-metallic Paints

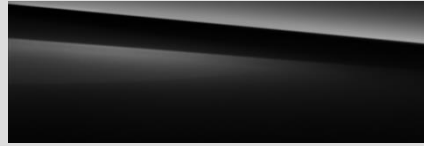

040
Black
Option price: \$0



149
Polar White
Option price: \$0

Metallic Paints

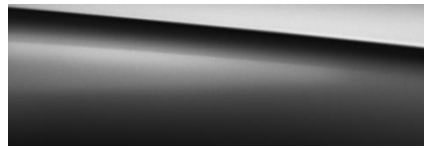

197
Obsidian Black
Option price: \$720

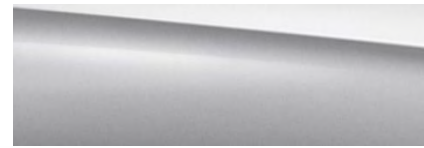

775
Iridium Silver
Option price: \$720



796
Dakota Brown
Option price: \$720

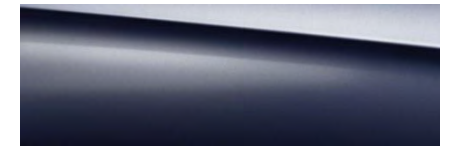

890
Lunar Blue
Option price: \$720

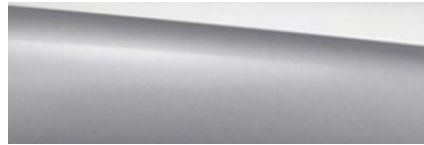

988
Diamond Silver
Option price: \$720

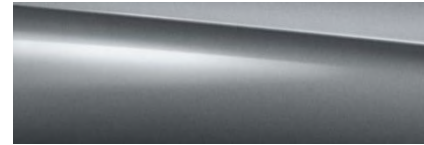

992
Selenite Grey
Option price: \$720

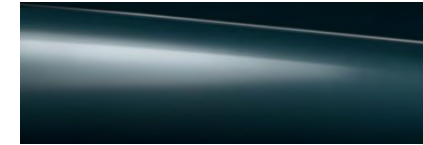

997
Piedmont Green
Option price: \$720

designo® Paints



996
Cardinal Red
Option price: \$1,080



799
Diamond White
Option price: \$1,515

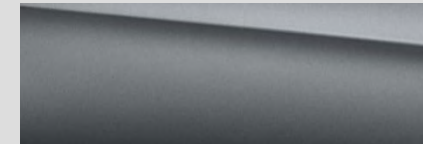

297
Selenite Grey Magno
Option price: \$3,950



R31
18" 5-Spoke Wheels
R02, R66
Option price: \$0
Requires Sport Styling (321)

RQR
18" AMG 5-Spoke Wheels
R02, R66
Option price: \$0
Requires AMG Line Exterior (322)

RQQ
18" AMG 5-Spoke Wheels
w/ Black Accents
R02, R66
Option price: \$0
Requires Night Package (521)

RTK
19" AMG Twin 5-Spoke Wheels
R02, R66
Option price: \$500
Requires AMG Line Exterior (322)



R54
18" Twin 5-Spoke Wheels
R02, R66
Option price: \$0
Requires Luxury Line (167)





<i>Code</i>	<i>Wheel Size</i>	<i>Description</i>	<i>Wheel Dimensions</i>	<i>Mobility</i>	<i>MSRP</i>
R54	18"	Twin 5-Spoke Wheels	245/45 R18 on 8.0 J x 18 ET 43	R02, R66	\$ 0 <i>Requires Luxury Line (167)</i>
R31	18"	5-Spoke Wheels	245/45 R18 on 8.0 J x 18 ET 43	R02, R66	\$ 0 <i>Requires Sport Styling (321)</i>
RQR	18"	AMG 5-Spoke Wheels	245/45 R18 on 8.0 J x 18 ET 43	R02, R66	\$ 0 <i>Requires AMG Line Exterior (322)</i>
RQQ	18"	AMG 5-Spoke Wheels w/ Black Accents	245/45 R18 on 8.0 J x 18 ET 43	R02, R66	\$ 0 <i>Requires Night Package (521)</i>
RTK	19"	AMG Twin 5-Spoke Wheels	245/40 R19 on 8.0 J x 19 ET 43	R02, R66	\$ 500 <i>Requires AMG Line Exterior (322)</i>



Interior Upholstery – Sport Styling (321)



121
Black
MB-Tex

Option price: \$0
Includes Crystal Grey Headliner (58U)



124
Nut Brown/Black
MB-Tex

Option price: \$0
Includes Black Headliner (51U)



125
Macchiato Beige/Black
MB-Tex

Option price: \$0
Includes Macchiato Beige Headliner (55U)



201
Black
Leather

Option price: \$1,620
Includes Crystal Grey Headliner (58U)



214
Nut Brown/Black
Leather

Option price: \$1,620
Includes Black Headliner (51U)



215
Macchiato Beige/Black
Leather

Option price: \$1,620
Includes Macchiato Beige Headliner (55U)

Interior Upholstery – Luxury Line (167)



131
Black
MB-Tex

Option price: \$0
Includes Crystal Grey Headliner (58U)



144
Nut Brown/Espresso Brown
MB-Tex

Option price: \$0
Includes Macchiato Beige Headliner (55U)



145
Macchiato Beige/Espresso Brown
MB-Tex

Option price: \$0
Includes Macchiato Beige Headliner (55U)



801
Black
Nappa leather

Option price: \$2,990
Includes Crystal Grey Headliner (58U)



814
Nut Brown/Espresso Brown
Nappa leather

Option price: \$2,990
Includes Macchiato Beige Headliner (55U)



815
Macchiato Beige/Espresso Brown
Nappa leather

Option price: \$2,990
Includes Macchiato Beige Headliner (55U)

Interior Upholstery – *designo* Nappa Leather



961+P62 Pkg

designo Black/Titanium Grey Pearl

Option price: \$4,900

Requires Premium 1, 2, 3 Pkg (P01, P02, P03)

Includes Black DINAMICA Headliner (61U)



975+P87 Pkg

designo Macchiato Beige/Saddle Brown

Option price: \$4,900

Requires Premium 1, 2, 3 Pkg (P01, P02, P03)

Includes Macchiato Beige DINAMICA Headliner (65U)





<i>Code</i>	<i>Upholstery</i>	<i>Seats</i>	<i>Floor Mats</i>	<i>Upper Dash/Lower Dash</i>	<i>Seat Belts</i>	<i>Steering Wheel</i>	<i>Headliner</i>
121	Black MB-Tex	Black	Black	Black/Black	Black	Black	Crystal Grey or Black ¹
124	Nut Brown/ Black MB-Tex	Nut Brown	Nut Brown	Black/Nut Brown	Black	Black	Black ²
125	Macchiato Beige/ Black MB-Tex	Macchiato Beige	Black	Black/ Macchiato Beige	Black	Black	Macchiato Beige or Black ¹
201	Black leather	Black	Black	Black/Black	Black	Black	Crystal Grey or Black ¹
214	Nut Brown/ Black leather	Nut Brown	Nut Brown	Black/Nut Brown	Black	Black	Black ²
215	Macchiato Beige/ Black leather	Macchiato Beige	Black	Black/Macchiato Beige	Black	Black	Macchiato Beige or Black ¹
131	Black MB-Tex	Black	Black	Black/Black	Black	Black	Crystal Grey
144	Nut Brown/ Espresso Brown MB-Tex	Nut Brown	Nut Brown	Espresso Brown/ Nut Brown	Nut Brown	Espresso Brown	Macchiato Beige
145	Macchiato Beige/ Espresso Brown MB-Tex	Macchiato Beige	Black	Macchiato Beige/ Nut Brown	Macchiato Beige	Espresso Brown	Macchiato Beige
801	Black Nappa leather	Black	Black	Black/Black	Black	Black	Crystal Grey
814	Nut Brown/ Espresso Brown Nappa leather	Nut Brown	Nut Brown	Espresso Brown/Nut Brown	Nut Brown	Espresso Brown	Macchiato Beige
815	Macchiato Beige/ Espresso Brown Nappa leather	Macchiato Beige	Espresso Brown	Espresso Brown/ Macchiato Beige	Macchiato Beige	Espresso Brown	Macchiato Beige

¹Black Headliner (51U) requires AMG Line Exterior (322)

²Nut Brown/Black Upholstery (124/214) includes Black Headliner (51U)

Interior Trims - Upper Trim



739

Aluminum trim

Special Order Option Charge: \$250



731

Burl walnut wood trim

Option price: \$0



H06

Brown Ash wood trim

Option price: \$0



H09

Natural Grain Brown Ash wood trim

Option price: \$tba

Includes matching Natural Grain Brown Ash Wood trim center console (730)



736

Natural Grain Black Ash wood trim

Option price: \$tba

Includes matching Natural Grain Black Ash wood center console (737)

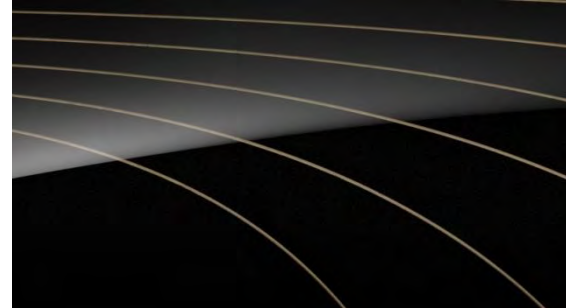

H16

designo Black Piano Lacquer Flowing lines wood trim

Option price: \$1,300



H26

designo Magnolia Flowing lines wood trim

Option price: \$1,300

Interior Trims - Center Console



728

Center Console in Black Piano Lacquer

Option price: \$0

Included w/ upper trims 731, 739, H06, H16 and H26



730

Center Console in Natural Grain Brown Ash wood

Option price: \$0

Included w/ Natural Grain Brown Ash wood trim (H09)



737

Center Console in Natural Grain Black Ash wood

Option price: \$0

Included w/ Natural Grain Black Ash wood trim (736)

Details on Image might differ from actual center console



<i>Code</i>	<i>Packages</i>	<i>Availability</i>	<i>MSRP</i>
P01	<p>Premium 1 Package</p> <ul style="list-style-type: none"> ▪ 234 – Blind Spot Assist ▪ 536 – SiriusXM® Radio w/ Free Trial Period ▪ 810 – Burmester® Surround Sound System ▪ 873 – Heated Front Seats ▪ 897 – Inductive Wireless Charging w/ NFC Pairing ▪ P17 – KEYLESS-GO Comfort Pkg <ul style="list-style-type: none"> ▪ 871 – Hands-Free-Access ▪ 889 – KEYLESS-GO ▪ P44 – Parking Package code <ul style="list-style-type: none"> ▪ 235 Active Parking Assist 	All Models	\$ tba
P02	<p>Premium 2 Package</p> <p><i>Includes all Premium 1 Package (P01) features plus:</i></p> <ul style="list-style-type: none"> ▪ P35 – Lighting Package code <ul style="list-style-type: none"> ▪ 608 – Adaptive Highbeam Assist ▪ 640 – LED Intelligent Light System ▪ 464 – 12.3” Digital instrument cluster ▪ P09+313 – Rear door roller blinds ▪ P21 – Air Balance Package 	All Models	\$ tba
P03	<p>Premium 3 Package</p> <p><i>Includes all Premium 2 Package (P02) features plus:</i></p> <ul style="list-style-type: none"> ▪ 463 – Head-Up display ▪ P20 – Driver Assistance Package Plus ▪ P47 – Parking Package code <ul style="list-style-type: none"> ▪ 501 Surround View System 	All Models	\$ tba



<i>Code</i>	<i>Packages</i>	<i>Availability</i>	<i>MSRP</i>
167	<p>Luxury Line <i>Not available with Sport Styling (321)</i></p> <ul style="list-style-type: none"> ▪ 485 – Suspension with selective damping ▪ U09 – Topstitched MB-Tex upper dashboard and door trim ▪ Luxury radiator grille w/ Mercedes-Benz Star on Hood ▪ Galvanized shift paddles ▪ Wheel Choice of: <ul style="list-style-type: none"> ▪ R54 – 18” Twin 5-Spoke Wheels with all-season, run-flat tires 	All Models	\$ 500
321	<p>Sport Styling <i>Not available with Luxury Line (167)</i></p> <ul style="list-style-type: none"> ▪ 677 – Lowered suspension with selective damping ▪ 772 – AMG Body Styling ▪ Mercedes-Benz Star in radiator grille ▪ Wheel: <ul style="list-style-type: none"> ▪ R31 – 18” 5-Spoke Wheels with all-season, run-flat tires 	All Models	\$ 0
322	<p>AMG Line Exterior <i>Requires Sport Styling (321)</i></p> <ul style="list-style-type: none"> ▪ 51U – Black headliner ▪ Wheel Choice of: <ul style="list-style-type: none"> ▪ RQR – 18” AMG 5-Spoke Wheels with all-season, run-flat tires ▪ RTK – 19” AMG Twin 5-Spoke Wheels with all-season, run-flat tires (+\$500) 	All Models	\$ 500
521	<p>Night Package <i>Requires AMG Line Exterior (322)</i></p> <ul style="list-style-type: none"> ▪ P55 – Night Package code ▪ Gloss black elements: Front wing, lamellas, rear diffuser insert, exterior mirror covers, beltline, strip & window strip cover Wheel Choice of: <ul style="list-style-type: none"> ▪ RQQ - 18” AMG 5-Spoke Wheels w/ Black Accents 	All Models	\$ 300



<i>Code</i>	<i>Packages</i>	<i>Availability</i>	<i>MSRP</i>
P62	<p>designo Titanium Grey Pearl/Black Nappa Leather <i>Requires Premium 1, 2, 3 Pkg (P01, P02, P03)</i> <i>Available with all trim choices</i></p> <ul style="list-style-type: none"> ▪ 961 – <i>designo</i> Titanium Grey Pearl/Black Nappa leather seats in diamond quilt design, with black topstitching, and <i>designo</i> badge on backrests of front seats ▪ U04 – <i>designo</i> floor mats ▪ 61U – <i>designo</i> Black DINAMICA headliner ▪ U38 – Upper dashboard and doors in <i>designo</i> Titanium Grey Pearl Nappa leather with black topstitching ▪ Door and center console armrests in <i>designo</i> Black Nappa Leather 	All Models	\$ 4,900
P87	<p>designo Macchiato Beige/Saddle Brown Nappa Leather <i>Requires Premium 1, 2, 3 Pkg (P01, P02, P03)</i> <i>Available with all trim choices</i></p> <ul style="list-style-type: none"> ▪ 975 – <i>designo</i> Macchiato Beige / Saddle Brown Nappa leather seats in diamond quilt design, with beige topstitching, and <i>designo</i> badge on backrests of front seats ▪ U04 – <i>designo</i> floor mats ▪ 65U – <i>designo</i> Macchiato Beige DINAMICA headliner ▪ U38 – Upper dashboard and doors in <i>designo</i> Saddle Brown Nappa leather with silk beige topstitching ▪ Door and center console armrests in <i>designo</i> Macchiato Beige Nappa leather 	All Models	\$ 4,900
445	<p>Warmth and Comfort Package <i>Not available with heated front seats (873)</i></p> <ul style="list-style-type: none"> ▪ P68 – Warmth and Comfort Package ▪ 906 – Heated Armrests ▪ 902 – Rapid Heating Functionality for Front Seats ▪ 443 – Heated Steering Wheel ▪ 431 – Galvanized Shift Paddles 	All Models	\$ 600

Stand-Alone Options



<i>Code</i>	<i>Options</i>	<i>Availability</i>	<i>MSRP</i>
PAF	Acoustic Comfort Package <i>Increased Cabin Insulation, Windshield and Side Windows with Acoustic and Heat Absorbing Membrane</i> ▪ 596 – Infrared Glass	All Models	\$ 1,100
L3D	Wood/leather steering wheel <i>Requires burl walnut wood trim (731)</i> <i>Not available with 445 Package or heated steering wheel (443)</i>	All Models	\$ 590
U25	Illuminated door sills with “Mercedes-Benz” lettering	All Models	\$ tba
U80	115V AC Power Outlet	All Models	\$ 115
234	Blind Spot Assist <i>Not available with P01, P02 or P03 Premium Packages</i>	All Models	\$ 550
293	Rear side air bags	All Models	\$ tba
401	Heated and Ventilated Front Seats <i>Requires leather (2xx)/ Nappa leather (8xx) upholstery</i> <i>Not available with heated front seats (873)</i>	All Models	\$ 450
413	Panorama Roof	All Models	\$ 1,090
432	Active Multicontour Front Seats w/ Massage Feature <i>Not available with heated front seats (873)</i> ▪ 902 – Rapid Heating Functionality for Front Seats ▪ 436 – Luxury Front Headrests	All Models	\$ tba
443	Heated Steering Wheel	All Models	\$ 250
489	AIR BODY CONTROL air suspension	All Models	\$ 1,900
536	SiriusXM® Radio w/ Free Trial Period <i>Not available with P01, P02 or P03 Premium Packages</i>	All Models	\$ 460
581	3-Zone climate control	All Models	\$ tba
608	Adaptive Highbeam Assist <i>Not available with P02 or P03 Package</i>	All Models	\$ 250

Stand-Alone Options



<i>Code</i>	<i>Options</i>	<i>Availability</i>	<i>MSRP</i>
866	Rear Seat Entertainment and Comfort Adapter	All Models	\$ tba
873	Heated Front Seats <i>Not available with 401, 432 or 445 Package</i>	All Models	\$ 750
883	Soft-close doors	All Models	\$ tba
<i>Code</i>	<i>Special Order Options (additional charge of \$250)</i>	<i>Availability</i>	<i>MSRP</i>
RQJ	18" AMG 5-Spoke Wheels <i>Requires AMG Line Exterior (322)</i>	All Models	\$ 0
872	Heated Rear Seats <i>Requires one of the following heated front seat options: 873, P01, P02, P03, 432 or 401 and leather (2xx) or Nappa leather (8xx) upholstery</i>	All Models	\$ 620
<i>Code</i>	<i>Mercedes-Benz Accessories Program</i>	<i>Availability</i>	<i>MSRP</i>
00A	Illuminated Star <i>Not available with Premium Package (P03) or Luxury Line (167)</i>	All Models	\$ 450
068	Wheel Locks	All Models	\$ 150
070	Chrome Door Handle Inserts (Set of 4)	All Models	\$ 100
11A	Black Mirror Housing	All Models	\$ tba
15A	LED Logo Projectors	All Models	\$ tba



Headlamps



LED headlamps (632)

Standard

- All functions feature LED technology
- Excellent illumination of the road
- Distinctive look during day and night
- Integrated LED daytime running lamps
- Projector LED low-beam and reflective LED high-beam technology
- LED taillamps (w/stardust effect)
- Low energy consumption
- Much longer bulb life



LED Intelligent Light System (640)

Optional

Included in Premium 2 Package (P02)

All functions of the standard LED headlamps plus:

- Automatic high-beam control by Adaptive Highbeam Assist
- Automatically activated cornering lights
- Active light function for significantly better illumination in bends
- Pairs w/ standard LED taillamps



Steering Wheels



3-Spoke multifunction steering wheel (L3C)

Standard

- The all new 3-spoke steering wheel in Nappa leather comes with unique Touch Control Buttons in the control panels on the left and right.
- The steering wheel is embossed in the center grip area.
- Galvanized shift paddles, only with Luxury Line (167)



Wood/leather steering wheel (L3D)

Optional

Requires Burl walnut wood trim (731)

Not available with heated steering wheel (443)

- The combination of high-quality leather in the grip area and fine wood inserts at the top and bottom make this steering wheel a visual and tactical highlight.
- Galvanized shift paddles



Heated Steering Wheel (443)

Optional

Not available with wood/leather steering wheel (L3D)

- On cold days, heating of the steering wheel rim very rapidly ensures cozy temperatures of the grip area and thus also warm hands.
- The switch for turning the heating on and off is positioned right next to the steering wheel.
- Galvanized shift paddles

Active Brake Assist



Active Brake Assist

Standard on all models

- Radar-based driving assistance system that can help prevent accidents with vehicles ahead and with crossing pedestrians or mitigate the consequences of accidents
- Combination of proximity warning, collision warning, on-demand braking assistance and autonomous braking function
- Additional audible warning if the distance diminishes rapidly
- If the driver initiates emergency braking – if necessary – increase in braking pressure by the on-demand braking assistance
- Initiation of autonomous braking if the driver fails to react
- Visual and audible warning plus almost simultaneous emergency braking if an impending collision with a **crossing pedestrian** is detected

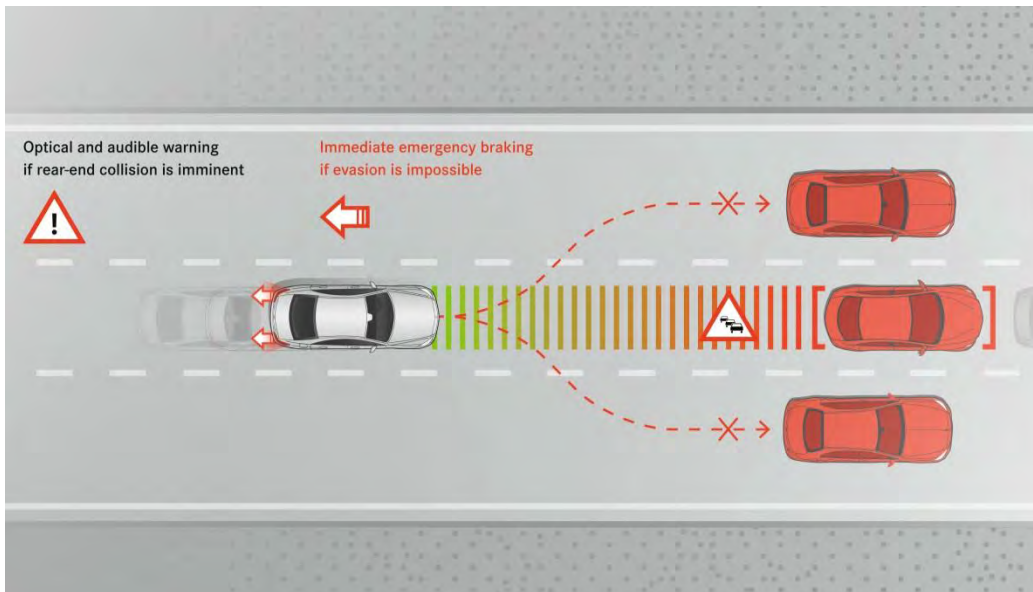



Crosswind Assist

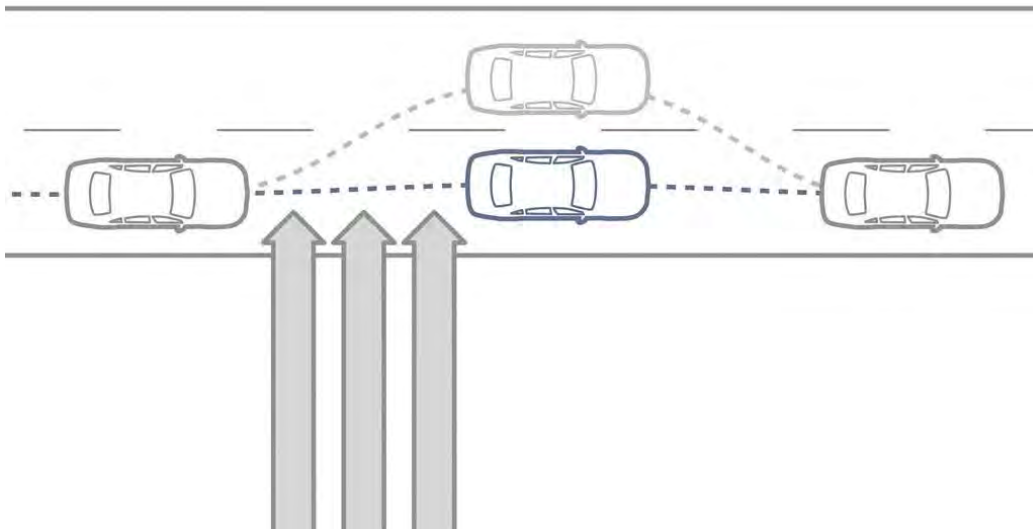

Crosswind Assist

Standard on all models

- Traditionally, strong gusts of wind may lead to sudden lateral drift of the vehicle
- Crosswind Assist aids the driver by reducing the vehicle's lateral drift substantially in windy driving conditions
- Crosswind Assist is integrated into the ESP® sensor system and enables the timely detection of gusts of crosswind
- Automatic brake intervention on the wheels on the side of the vehicle facing the wind results in a motion which counteracts the crosswind
- Crosswind Assist substantially enhances the driver's sense of control, stability and safety



AIR BODY CONTROL (489)

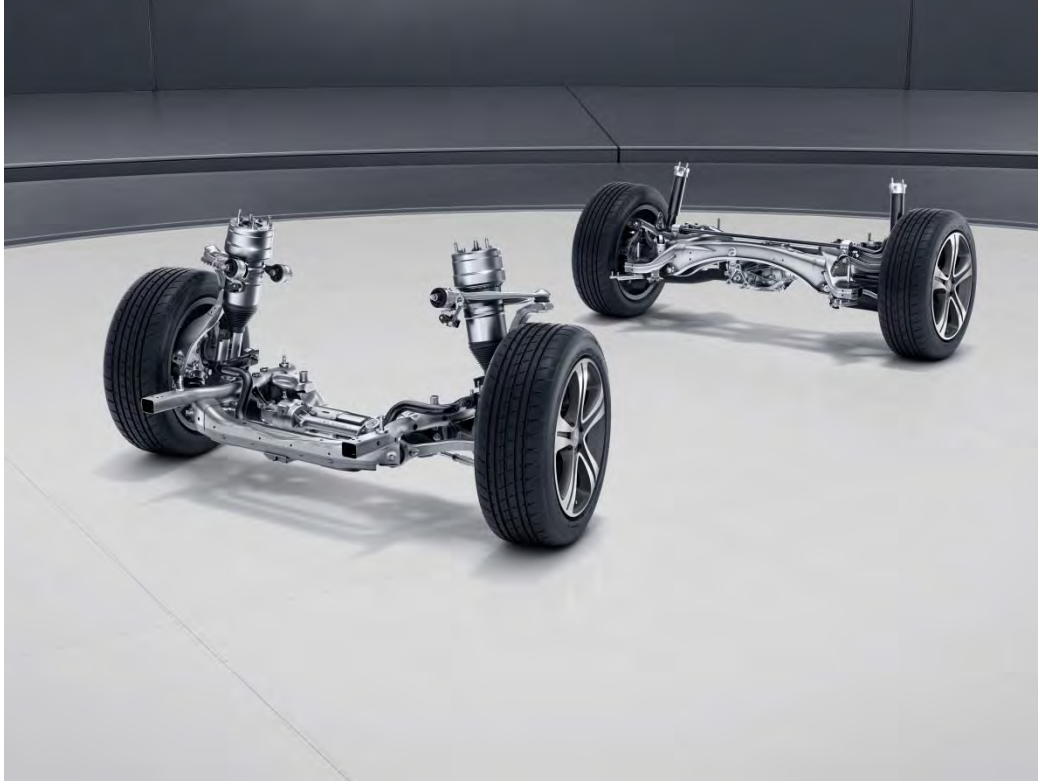

AIR BODY CONTROL (489)

Option Price: \$1,900

- Multi-chamber air suspension combined with continuously adjustable damping to improve ride comfort and driving dynamics
- Vehicle characteristics can be varied from comfortable through to sporty using DYNAMIC SELECT switch
- "Comfort" and "Sport" settings for a more comfortable or stiffer, sportier setup
- Constant vehicle level irrespective of load thanks to pneumatic all-round self-levelling suspension
- Suspension level can be raised for poor surfaces and is automatically lowered at high speeds, helping to reduce aerodynamic drag and further improve handling stability





Burmester® Surround Sound System (810)



Burmester® Surround Sound System (810)

Included in Premium 1 Package (P01)

- 13 high-performance speakers precisely configured for the vehicle interior to ensure well-balanced and very dynamic music reproduction
- 9-channel DSP amplifier with a total output of 590 watts (7 x 50 W and 2 x 120 W) for maximum sound quality with very high volume reserves
- Frontbass® technology with woofers integrated into the dash for vibrant bass reproduction
- Combination of digital and analogue filter elements for the unique Burmester® "feel-good sound"
- Sound optimization for the front and rear seats
- Noise compensation (VNC)
- Sound preset: surround function to generate virtual all-round sound
- Support for popular multi-channel formats such as Dolby Digital 5.1/DTS for example, for true surround sound



Mercedes-Benz Intelligent Drive – Overview



Mercedes-Benz Intelligent Drive – Overview

Included in Premium 3 Package (P03)

“Mercedes-Benz Intelligent Drive” is a gateway to a more autonomous & accident-free driving which increases safety for all drivers on the road. The following lists all features that are available with the all new E-Class:

- Active Distance Assist DISTRONIC®, Active Steering Assist, Active Lane Change Assist, Active Emergency Stop Assist, and Active Speed Limit Assist
- **Active Brake Assist with Cross-Traffic Function**
- **Evasive Steering Assist**
- PRE-SAFE® PLUS
- **PRE-SAFE® Impulse Side**
- Active Lane Keeping Assist
- Active Blind Spot Assist





Mercedes-Benz Intelligent Drive

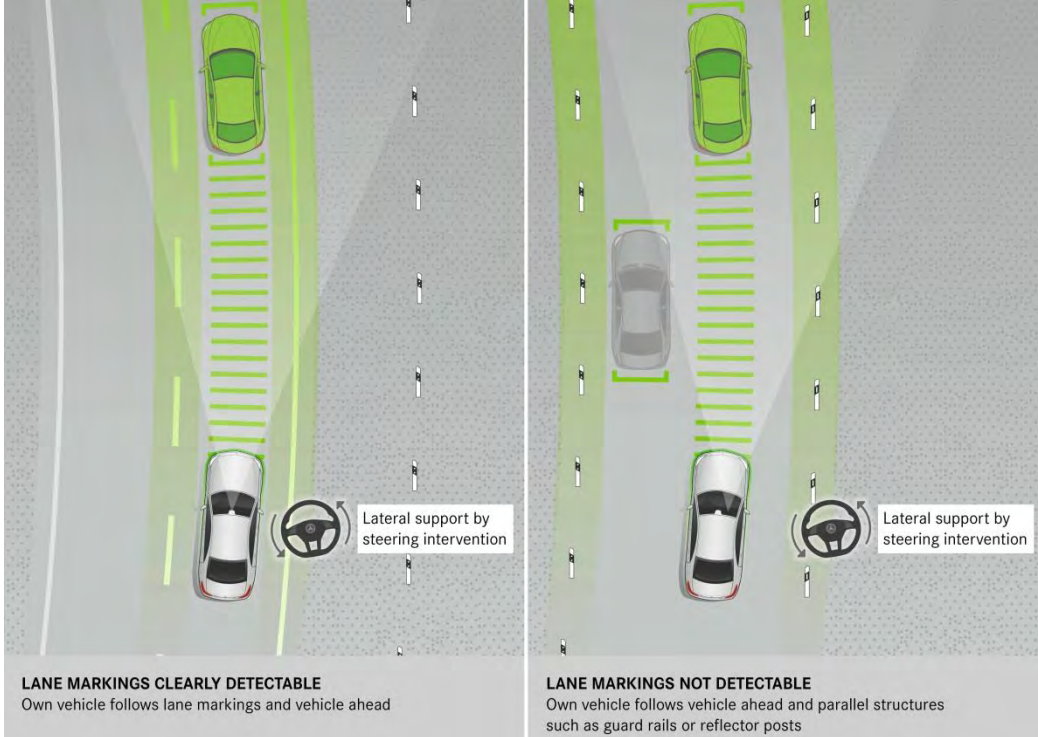

Mercedes-Benz Intelligent Drive Included in Premium 3 Package (P03)

- Active Steering Assist generates steering torque which helps the driver to keep the vehicle in the center of its lane (straight roads and slight bends), taking its guidance from vehicles ahead and road lane markings
- Active Lane Change Assist helps the driver with changing lanes by means of steering torque when the driver initiates the change by activating the turn indicator and the system does not detect another vehicle in the adjacent lane
- Extended tolerance for the hands-off warning of Active Steering Assist with intelligent hands-on detection
- Active Emergency Stop Assist brakes the vehicle to a controlled stop if the system detects that the driver is permanently distracted or is no longer able to operate the vehicle
- Active Distance Assist DISTRONIC® maintains the selected distance from the vehicle in front, and works in the speed range from 0 – 130 mph, also reacting to stationary vehicles at low speeds





Mercedes-Benz Intelligent Drive – Active Brake Assist with Cross-Traffic Function

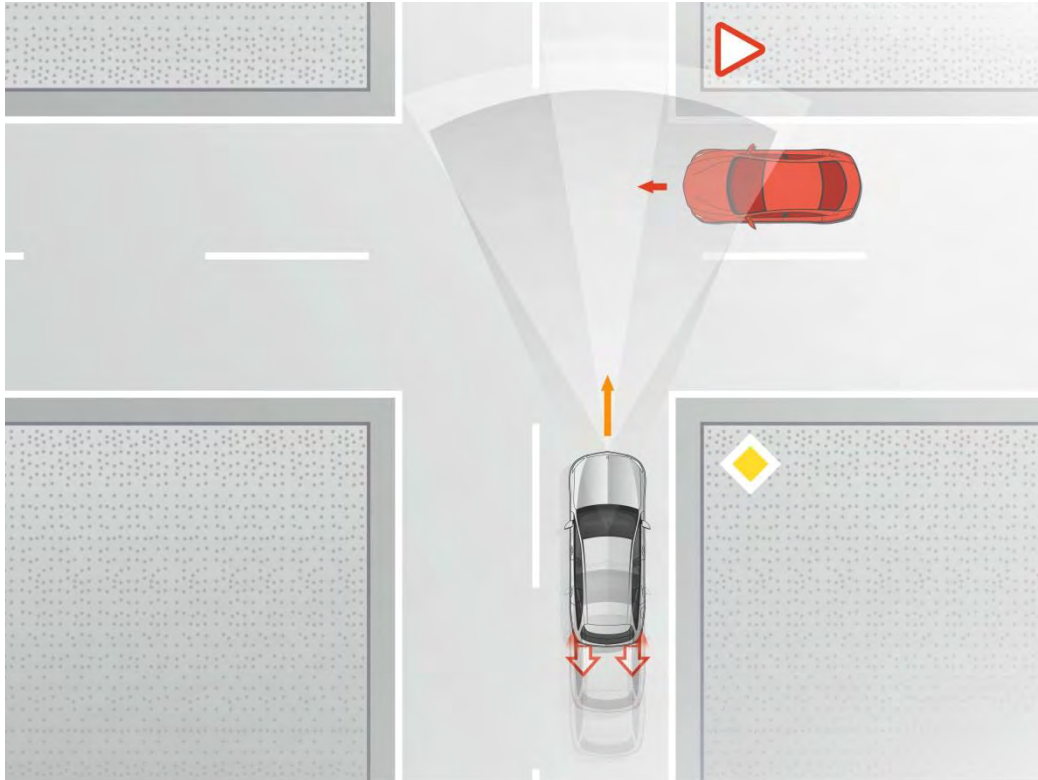

Mercedes-Benz Intelligent Drive – Active Brake Assist with Cross-Traffic Function

Included in Premium 3 Package (P03)

- The system is able to reduce the risk of collisions and accidents at road junctions
- Monitoring of traffic situation ahead of the vehicle by means of radar sensors and stereo multipurpose cameras
- Vehicles travelling ahead are detected up to a speed of 130 mph
- Crossing traffic and bicyclists are registered up to a speed of 45 mph, as well as pedestrians who are stationary or moving slowly in the path of the vehicle
- When danger of a collision is detected, the system gives a visual and audible warning and brakes
- If the driver firmly applies the brakes, the system calculates the brake pressure that would be needed to prevent a collision
- If a collision cannot be prevented, the impact speed is reduced as much as possible by emergency braking



Mercedes-Benz Intelligent Drive – Evasive Steering Assist

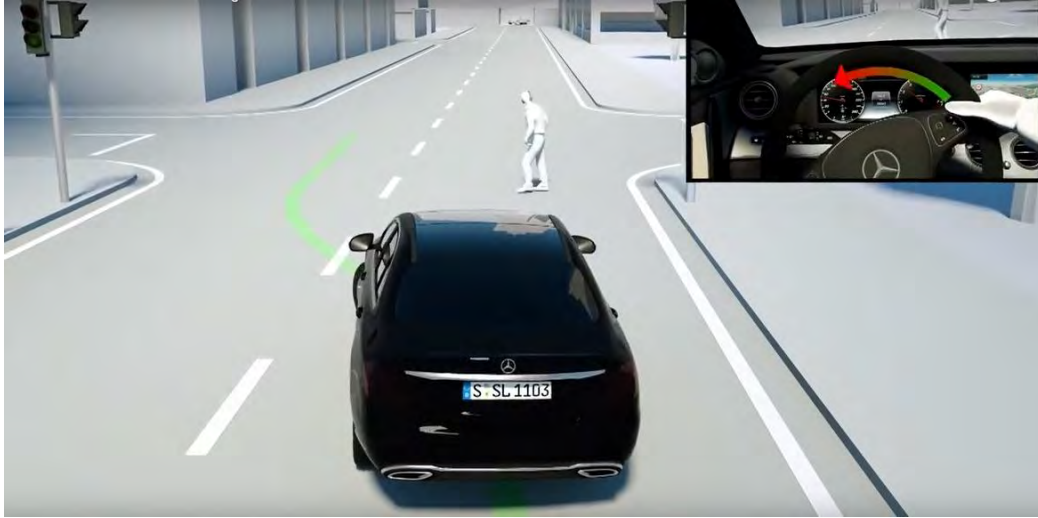

Mercedes-Benz Intelligent Drive – Evasive Steering Assist

Included in Premium 3 Package (P03)

- When the driver deliberately or instinctively performs an evasive maneuver in a dangerous situation (pedestrian crossing the street), Evasive Steering Assist provides assistance by adding precisely calculated steering torque to support the movement of the steering wheel
- This helps the driver to avoid a pedestrian in a controlled manner while subsequently facilitating the movement of the vehicle to allow the situation be negotiated safely





Mercedes-Benz Intelligent Drive – PRE-SAFE Impulse Side

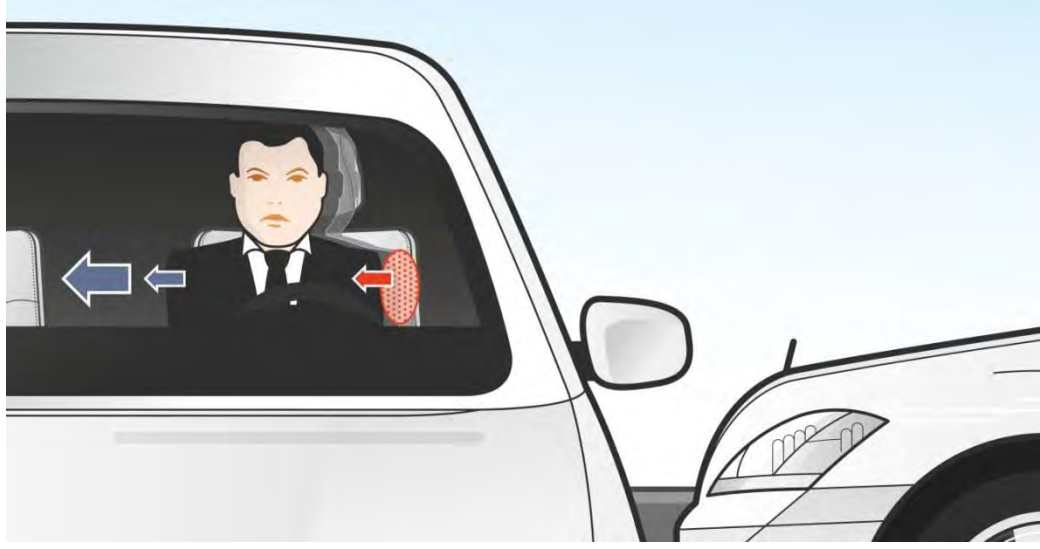

Mercedes-Benz Intelligent Drive – PRE-SAFE® Impulse Side

Included in Premium 3 Package (P03)

- PRE-SAFE® Impulse Side initiates preventative protective measures against an impending side impact, supplementing the measures taken by PRE-SAFE® and PRE-SAFE® PLUS
- In the event of a side impact, PRE-SAFE® Impulse Side can have a positive effect by increasing the distance between the occupant and the door, and at the same time reducing the relative speeds between the side structure and the occupant's torso
- In the event of a recognized, unavoidable side collision, the system can give the driver or front passenger a slight push towards the center of the vehicle on the side facing the impact
- This lateral impulse is initiated by very rapid inflation of an air chamber in the seat bolster





designo Black/Titanium Grey Pearl (P62)





designo Macchiato Beige/Saddle Brown (P87)





Panorama roof (413)





Trunk compartment





	<i>E 400 4MATIC</i>
Engine Configuration	3.0L V6 biturbo engine
Power (hp)	329
Torque (lb-ft)	354
Displacement (cc)	2,996
Acceleration 0-60 mph (sec)	5.3 est.
Fuel Economy (Cty/Hwy/Comb)	tba
Top Speed (mph)	130
Fuel Requirement (Octane)	91
# Valves per cylinder	4
Compression	10.5:1
Transmission	9G-TRONIC 9-Speed Automatic Transmission
Transmission Speeds	9
Drive Configuration	All-wheel drive
Fuel Tank Size (gallons)	21.1
Trunk Size (cubic feet)	35.0
Curb Weight (lbs)	4,299
Vehicle Length (in.)	194.2
Vehicle Width w/ exterior mirrors (in.)	81.3
Vehicle Height (in.)	57.7
Wheelbase (in.)	115.7
Track Width Front/Rear (in.)	62.7/63.0

Specifications* – E 400 4MATIC Luxury Line (167)

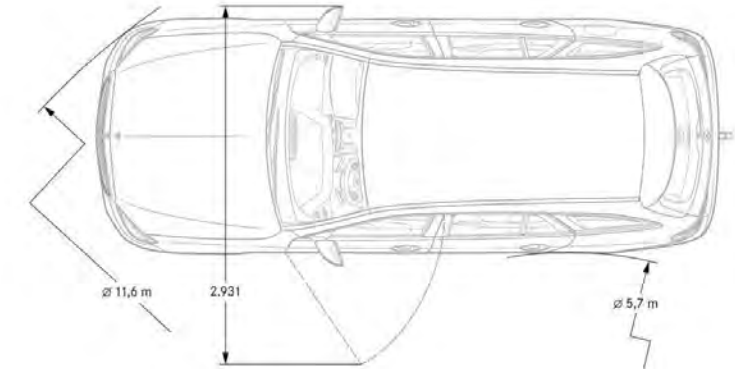
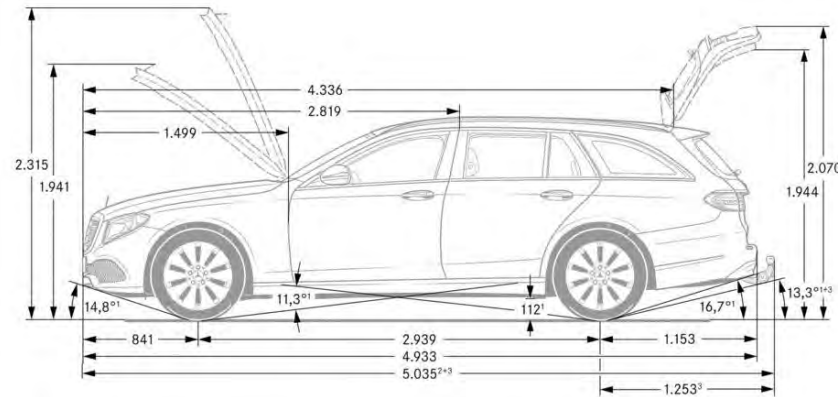
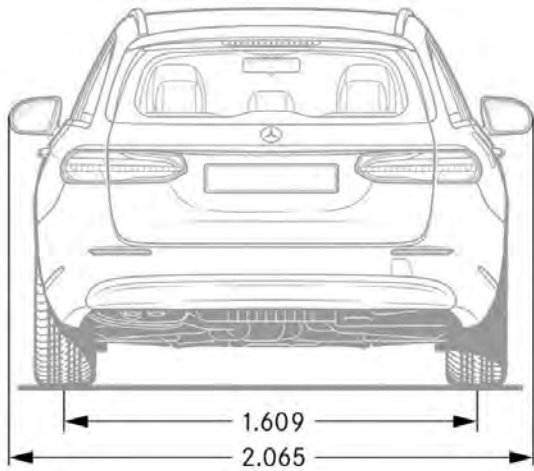
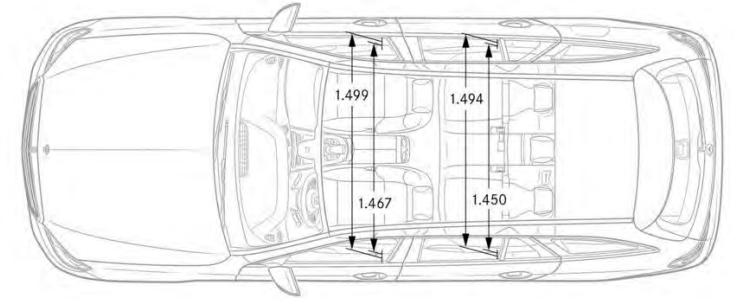
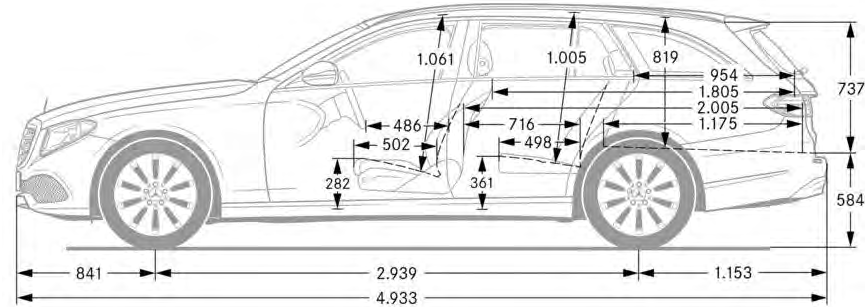
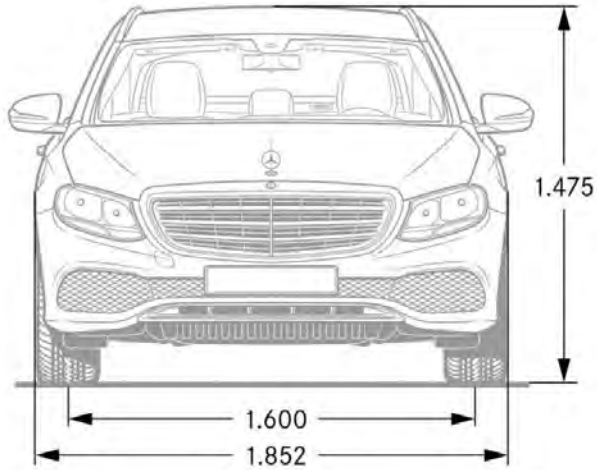

E-Class Wagon



Model Year 2018

Preliminary

AMG
DRIVING PERFORMANCE

E63S



Models



What's new?



Standard Equipment

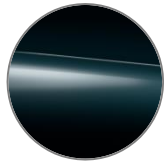

Exterior Paint Colors



Wheels



Interior Upholstery



Interior Trims



Option Packages



Stand-Alone Options



Options in Detail



Specifications



AMG E63 S (213.289)

- MSRP \$TBD
- Handcrafted AMG 4.0L V8 biturbo engine
- 603 hp
- 627 lb-ft
- 3.4 sec (0-60 mph)
- Launch Date Fall 2017

Variants

- Mercedes-AMG E 63 S Wagon

Standard Equipment

- AMG Performance 4MATIC+ all-wheel drive
- Blind Spot Assist
- 20" AMG wheels
- AMG Dynamic Engine Mounts
- Sliding Panorama Roof
- AMG SPEEDSHIFT® MCT 9-speed transmission
- LED headlamps

Optional Equipment

- Soft-close doors
- 3-zone climate control
- AMG Nut Brown Nappa leather
- AMG Macchiato Beige Nappa leather
- designo* Magnolia w/ Flowing Lines wood
- designo* Black Piano Lacquer Flowing Lines wood
- Metal Weave trim
- AMG Carbon Fiber center console trim
- Natural Grain Black Ash Wood center console trim
- Intelligent Drive systems
- Warmth & Comfort Package
- Acoustic Comfort Package

Paints

- Brilliant Blue metallic
- Selenite Grey metallic
- Piedmont Green metallic
- designo* Selenite Grey Magno

Performance - 2016 E 63 S (S212) vs. 2018 E 63 S (S213)

	<i>2016 E63S</i>	<i>2018 E63S</i>
Engine Configuration	Handcrafted AMG 5.5L V8 biturbo engine	Handcrafted AMG 4.0L V8 biturbo engine
Power (hp)	577	603
Torque (lb-ft)	590	627
Displacement (cc)	5,461	3,982
Acceleration 0-60 mph (sec)	3.5	3.4
Top Speed (mph)	186 (electronically limited)	180 (electronically limited)
# Valves per cylinder	4	4
Compression	10.50 : 1	8.6:1
Transmission	AMG SPEEDSHIFT MCT	AMG SPEEDSHIFT MCT
Transmission Speeds	7	9
Drive Configuration	AMG Performance 4MATIC all-wheel drive with 33:67 torque split	AMG Performance 4MATIC+ all-wheel drive with fully variable torque distribution

AMG Performance 4MATIC+



The performance-oriented all-wheel drive with fully variable torque distribution combines optimum traction, hallmark AMG driving dynamics and the ultimate in driving enjoyment. It enhances driving safety and adhesion on wet or wintry road surfaces while the same time allowing an emotional drifting experience. This is made possible by the fully variable torque distribution, offering the driver the benefits of all-wheel drive and rear-wheel drive in equal portion.

An electronically controlled clutch provides for variable connection of the permanently driven rear axle with the front axle. The ideal torque distribution is calculated continuously, according to the given driving situation and the driver's wishes. This enables a seamless transition from traction-oriented all-wheel drive to 100% rear-wheel drive. In addition to traction and transverse dynamics, the all-wheel drive also improves the longitudinal dynamics of the vehicle for even more dynamic acceleration.

- Combines the advantages of an all-wheel drive with those of a rear-wheel drive: optimum traction, hallmark AMG vehicle dynamics and maximum driving pleasure
- Drift capability, as fully variable torque distribution means that 100% rear-wheel drive is possible
- Improved handling safety and road holding on wet or wintry road surfaces
- Improved longitudinal dynamics for even more aggressive acceleration
- The compact, lightweight design avoids any loss of space in the interior

AMG SPEEDSHIFT MCT 9-Speed Sport Transmission



MCT stands for Multi-Clutch Transmission, whereby an innovative wet start-off clutch running in an oil bath replaces the conventional torque converter. Thanks to its low rotational inertia, the transmission responds instantaneously without the losses typical of a torque converter. This helps to reduce fuel consumption. A further merit of the MCT transmission is its low weight thanks to its magnesium housing.

Added driving pleasure, added safety – the double-clutching function

Ultra-fast, responsive multiple downshifts are another forte of the AMG SPEEDSHIFT MCT 9-speed sport transmission. The driver can change via kickdown directly from 9th into 6th or from 5th into 2nd gear, for example. The automatic double-clutching function is active in drive programs "S", "S+", "RACE" and "M". Each manual or automatic downshift is accompanied by a precisely metered blip on the throttle – with rising intensity from "S" through to "RACE" and "M". This not only heightens the emotional appeal: downshifting minimizes the load cycles, which has a particularly positive effect when braking into corners and makes for improved handling safety on wet and slippery surfaces.

For a perfect start – the RACE START function

The RACE START function ensures optimal acceleration from a standing start. It can be activated when the vehicle is stationary in the AMG DYNAMIC SELECT drive programs "S", "S+" or "RACE". To activate, the driver is required to hold down the brake pedal with their left foot while simultaneously flooring the accelerator pedal (kickdown). The driver can then increase or lower the pulling-away engine speed as appropriate, according to the prevailing road conditions. When the driver now releases the brakes while continuing to floor the accelerator pedal, the vehicle accelerates with the best possible traction.

Performance & Handling

- Handcrafted AMG 4.0L V8 biturbo engine
- AMG SPEEDSHIFT® MCT (Multi Clutch Technology) 9-speed transmission
- AMG Performance 4MATIC+ all-wheel drive with fully variable torque distribution
- AMG Cylinder Management
- AMG Sport Suspension based on AIR BODY CONTROL
- 20" AMG Wheels
- AMG DYNAMIC SELECT

Comfort & Convenience

- Multicolor ambient lighting
- Auto-dimming rearview and driver-side mirrors
- Bluetooth® connectivity
- COMAND® navigation
- HomeLink® garage door opener
- LED Headlamps
- Powered front seats w/ 3-position memory and 4-way power driver's lumbar support
- Power folding mirrors
- Panorama sunroof
- Smartphone integration with Apple CarPlay™ & Android Auto
- Split-folding rear seats (40/20/40)
- Steering wheel with Touch Control Buttons
- Touchpad w/ central controller
- 5 years of mbrace® Connect
- Active Parking Assist
- NFC wireless charging
- SiriusXM Radio w/ free trial period
- AMG Nappa Leather upholstery
- Nappa Leather Dashboard
- Heated and ventilated front seats
- Power Tailgate
- KEYLESS-START
- KEYLESS-GO Comfort Package
 - HANDS-FREE ACCESS
 - Electronic trunk closer
 - KEYLESS-GO®

Safety & Security

- Active Brake Assist
- ATTENTION ASSIST®
- Car-to-X Communication
- Crosswind Assist
- LED Headlamps and Taillamps
- PRE-SAFE®
- PRE-SAFE® Sound
- Tire Pressure Monitoring System (TPMS)
- Blind Spot Assist
- Rearview Camera

Non-metallic Paints

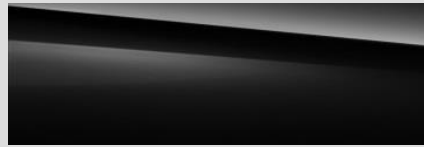

040
Black
Option price: \$0



149
Polar White
Option price: \$0

Metallic Paints



197
Obsidian Black
Option price: \$TBD



775
Iridium Silver
Option price: \$TBD



796
Dakota Brown
Option price: \$TBD



890
Lunar Blue
Option price: \$TBD

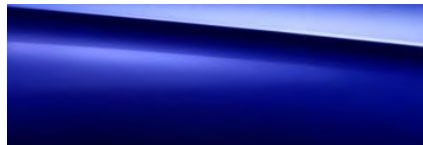

896
Brilliant Blue
Option price: \$TBD



988
Diamond Silver
Option price: \$TBD



992
Selenite Grey
Option price: \$TBD



997
Piedmont Green
Option price: \$TBD

designo® Paints



996
Cardinal Red
Option price: \$TBD



799
Diamond White
Option price: \$TBD

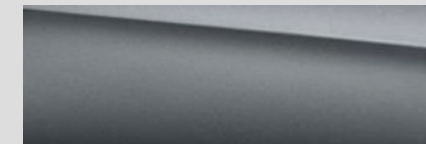

297
Selenite Grey Magno
Option price: \$TBD



RTM
20" AMG Twin 5-Spoke Wheels
w/ Grey Accents
Option price: \$0



RTQ
20" AMG Twin 5-Spoke Wheels
w/ Matte Grey Accents
Option price: \$X,XXX



RTP
20" AMG Twin 5-Spoke Wheels
w/ Black Accents
Option price: \$X,XXX



RTR
20" AMG Forged Cross-Spoke
Wheels w/ Grey Accents
Option price: \$X,XXX



RTS
20" AMG Forged Cross-Spoke
Wheels, Matte Black
Option price: \$X,XXX

<i>Code</i>	<i>Wheel Size</i>	<i>Description</i>	<i>Wheel Dimensions</i>	<i>Mobility</i>	<i>MSRP</i>
RTM	20"	AMG Twin 5-Spoke Wheels w/ Grey Accents	265/35 ZR20 on 9.5J x 20H2 ET25 (Front) 295/30 ZR20 on 10.0J x 20H2 ET55 (Rear)	R01, B51	\$ 0
RTQ	20"	AMG Twin 5-Spoke Wheels w/ Matte Grey Accents	265/35 ZR20 on 9.5J x 20H2 ET25 (Front) 295/30 ZR20 on 10.0J x 20H2 ET55 (Rear)	R01, B51	\$ TBD
RTP	20"	AMG Twin 5-Spoke Wheels w/ Black Accents	265/35 ZR20 on 9.5J x 20H2 ET25 (Front) 295/30 ZR20 on 10.0J x 20H2 ET55 (Rear)	R01, B51	\$ TBD
RTR	20"	AMG Forged Cross-Spoke Wheels w/ Grey Accents	265/35 ZR20 on 9.5J x 20H2 ET25 (Front) 295/30 ZR20 on 10.0J x 20H2 ET55 (Rear)	R01, B51	\$ TBD
RTS	20"	AMG Forged Cross-Spoke Wheels, Black	265/35 ZR20 on 9.5J x 20H2 ET25 (Front) 295/30 ZR20 on 10.0J x 20H2 ET55 (Rear)	R01, B51	\$ TBD



Interior Upholstery – Exclusive Nappa Leather



554

AMG Nut Brown/Black

Option price: \$0

Image shows AMG Performance seats (555)



555

AMG Macchiato Beige/Black

Option price: \$0

Image shows AMG Performance seats (555)



561

AMG Black w. Silver Contrast Stitching

Option price: \$0



61U

designo Black DINAMICA Headliner
w/ Leather Grab Handles

\$tbd

Available with all upholsteries



65U

designo Macchiato Beige DINAMICA Headliner
w/ Leather Grab Handles

\$tbd

Requires 555 upholstery

<i>Code</i>	<i>Upholstery</i>	<i>Seats</i>	<i>Floor Mats</i>	<i>Upper Dash/Lower Dash</i>	<i>Seat Belts</i>	<i>Steering Wheel</i>	<i>Headliner</i>
554	AMG Nut Brown Nappa leather	Nut Brown	Black	Black	Black	Black	Black
555	AMG Macchiato Beige Nappa leather	Macchiato Beige	Black	Black	Black	Black	Black or Macchiato Beige
561	AMG Black Nappa leather	Black	Black	Black	Silver or Black	Black	Black

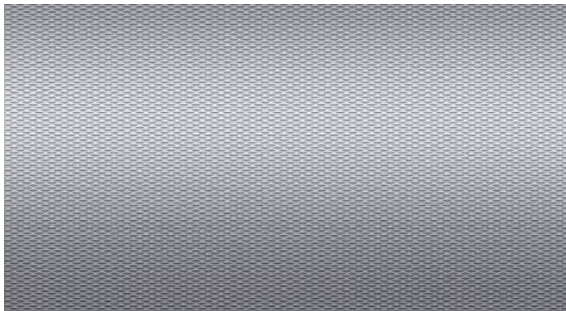

739

Trapeze Cut Aluminum trim

Option price: \$0

Requires High Gloss Black Center Console (728)

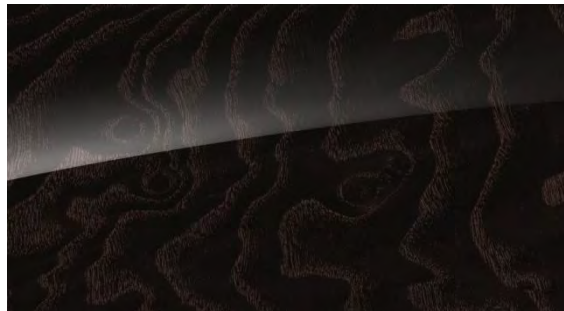

H06

High Gloss Brown ash wood trim

Option price: \$0

Includes High Gloss Black Center Console (728)



H09

Natural Grain Brown ash wood trim

Option price: \$0

Includes Natural Grain Brown ash wood Center Console (730)



736

Natural Grain Black ash wood trim

Option price: \$TBD

Includes Natural Grain Black Ash Wood Center Console (737)

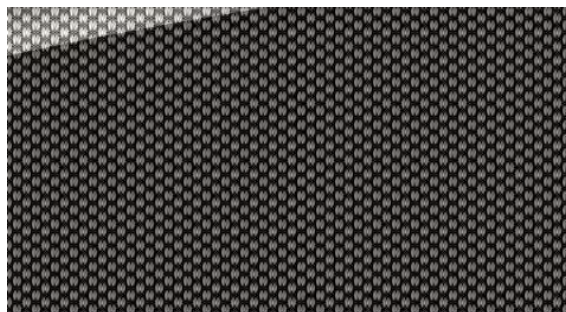

H64

Metal Weave trim

Option price: \$TBD

Includes High Gloss Black Center Console (728)

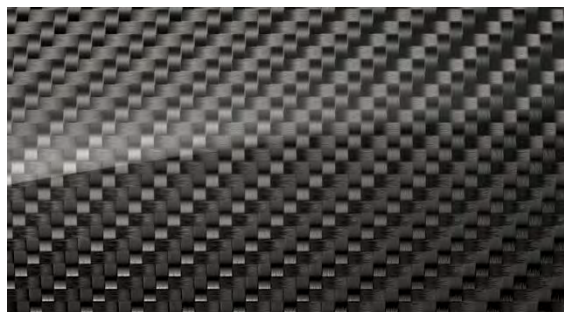

H73

AMG Carbon Fiber trim

Option price: \$TBD

Includes AMG Carbon Fiber Center Console (732)
Removes NFC Wireless Charging (897)

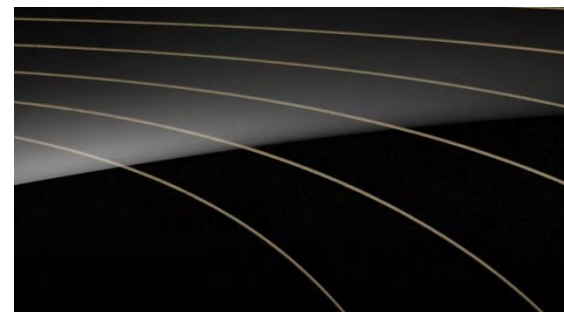

H16

designo Black Piano Lacquer Flowing lines wood trim

Option price: \$TBD

Includes High Gloss Black Center Console (728)

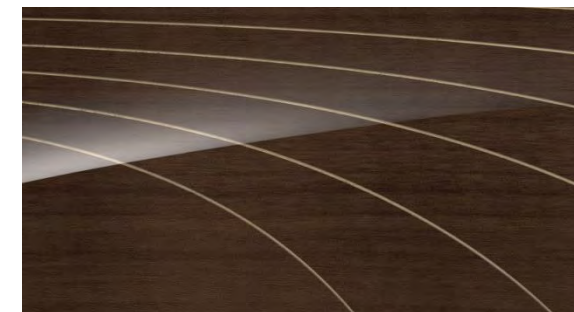

H26

designo Magnolia w/ Flowing lines wood trim

Option price: \$TBD

Includes High Gloss Black Center Console (728)

Interior Trims – Center Console Trim



728

High Gloss Black trim

Option price: \$0

Included with 739, H06, H64, H19 & H26 trims



737

Natural Grain Black Ash Wood trim

Option price: \$0

Requires Natural Grain Black Ash wood trim (736)



730

Center Console in Natural Grain Brown Ash wood

Option price: \$0

Included w/ Natural Grain Brown Ash wood trim (H09)



732

AMG Carbon Fiber trim

Option price: \$0

Requires AMG Carbon Fiber trim (H73)

Details on Image might differ from actual center console

Code	Packages	MSRP
P03	<p>AMG Premium Package <i>Not available with AMG Performance seats (555)</i></p> <ul style="list-style-type: none"> ▪ P20 – Driving Assistance Package <ul style="list-style-type: none"> ▪ Active Distance Assist DISTRONIC® and Active Steering Assist ▪ Active Lane Change Assist ▪ Active Brake Assist with Cross-Traffic Function ▪ Evasive Steering Assist ▪ Active Blind Spot Assist ▪ Active Lane Keeping Assist ▪ PRE-SAFE® PLUS ▪ PRE-SAFE® Impulse Side ▪ P47 – Parking Package code: <ul style="list-style-type: none"> ▪ Active Parking Assist ▪ Surround View Camera ▪ 463 – Head-Up Display 	\$ TBD
P04	<p>AMG Premium Package for AMG Performance Seats <i>Requires AMG Performance Seats (555)</i></p> <ul style="list-style-type: none"> ▪ 23P – Driver Assistance Package: <ul style="list-style-type: none"> ▪ Active Distance Assist DISTRONIC® and Active Steering Assist ▪ Active Lane Change Assist ▪ Active Brake Assist with Cross-Traffic Function ▪ Evasive Steering Assist ▪ Active Blind Spot Assist ▪ Active Lane Keeping Assist ▪ PRE-SAFE® PLUS ▪ P47 – Parking Package code: <ul style="list-style-type: none"> ▪ Active Parking Assist ▪ Surround View Camera ▪ 463 – Head-Up Display 	\$ TBD

<i>Code</i>	<i>Packages</i>	<i>MSRP</i>
PAF	<p>Acoustic Comfort Package</p> <ul style="list-style-type: none"> ▪ PAF – Acoustic Comfort Package <i>Increased Cabin Insulation, Windshield and Side Windows with Acoustic and Heat Absorbing Membrane</i> ▪ 596 – Infrared-reflecting glass 	\$ TBD
445	<p>Warmth & Comfort Package</p> <p><i>Not available with AMG Performance seats (555) or AMG Premium Package for AMG Performance Seats (P04)</i></p> <ul style="list-style-type: none"> ▪ P68 – Heated door panels & center console ▪ 902 – Rapid Seat Heating ▪ 906 – Heated Armrest 	\$ TBD
319	<p>AMG Advanced Lighting Package</p> <ul style="list-style-type: none"> ▪ P35 – Lighting Package code ▪ 608 – Adaptive Highbeam Assist ▪ 640 – LED Intelligent Lighting System 	\$ TBD
521	<p>AMG Night Package</p> <p><i>Can be combined with AMG Exterior Carbon Fiber Package (773)</i></p> <ul style="list-style-type: none"> ▪ P60 – AMG Exterior Night Styling <ul style="list-style-type: none"> ▪ High-gloss black front splitter ▪ High-gloss black side fender inserts ▪ High-gloss side sill panel inserts ▪ High-gloss black exterior mirror covers ▪ High-gloss black window frame trim ▪ High-gloss black trim strip on rear apron ▪ Black chrome exhaust tailpipe trim ▪ High-gloss black roof rails ▪ U50 – AMG Night Package Code 	\$ TBD

<i>Code</i>	<i>Packages</i>	<i>MSRP</i>
773	<p>AMG Exterior Carbon Fiber Package <i>Can be combined with AMG Night Package (521)</i></p> <ul style="list-style-type: none"> ▪ 773 – AMG Carbon Fiber Trim Package <ul style="list-style-type: none"> ▪ A-Wing on front apron in carbon fiber ▪ Side fender inserts in carbon fiber ▪ AMG side sill panel inserts in carbon fiber ▪ Insert in rear apron above rear diffuser in carbon fiber 	\$ TBD
313	<p>Sun Protection Package</p> <ul style="list-style-type: none"> ▪ P09 – Sun Protection Package Code <ul style="list-style-type: none"> ▪ Double sun visors for the driver and front passenger that extends with two folding sections ▪ 313 – Rear window manual roller blinds 	\$ TBD

<i>Code</i>	<i>Options</i>	<i>MSRP</i>
B07	AMG Ceramic Composite Braking System	\$ TBD
B14	AMG Carbon Fiber Engine Cover	\$ TBD
B28	AMG Carbon Fiber Exterior Mirror Covers	\$ TBD
L6J	AMG Nappa Leather Performance Steering Wheel	\$ TBD
P21	Air Balance Cabin Air Purification and Fragrance System	\$ TBD
U17	Black Seat Belts <i>Requires upholstery code 561 – AMG Black Nappa Leather. Standard for upholstery options 554 & 555.</i>	\$ 0
U78	AMG Performance Exhaust System	\$ TBD
U80	115V AC Power Outlet	\$ TBD
260	Deletion of deck lid badging	\$ TBD
261	Deletion of fender badging	\$ TBD
432	Active Multicontour Front Seats <i>Not available with AMG Performance Seats (555).</i>	\$ TBD
555	AMG Performance Seats <i>Not available with AMG Premium Package (P03) or Active Multicontour Seats (432).</i>	\$ TBD
581	3-zone Climate Control	\$ TBD
61U	Black DINAMICA Headliner	\$ TBD
65U	Macchiato Beige DINAMICA Headliner <i>Requires Macchiato Beige/Black Nappa upholstery (555).</i>	\$ TBD

Stand-Alone Options

<i>Code</i>	<i>Options</i>	<i>MSRP</i>
866	Rear Seat Entertainment and Comfort Adapter	\$ TBD
872	Heated Rear Seats	\$ TBD
883	Soft Close Doors	\$ TBD
<i>Code</i>	<i>VPC Installed Accessories</i>	<i>MSRP</i>
00A	Illuminated Star <i>Not with AMG Premium Package (P03) or AMG Premium Package for AMG Performance Seats (P04).</i>	\$ TBD
068	Wheel Locking Bolts	\$ TBD
070	Chrome Door Handle Inserts	\$ TBD
<i>Code</i>	<i>Special Order Options (SPC)</i>	<i>MSRP</i>
293	Rear Side Airbags	\$ TBD

Brakes



AMG High-Performance Composite Braking System (U70)

Standard

6-piston front and 1-piston rear calipers

- Front axle: Composite brake disc measuring 390 x 36 mm, internally ventilated and perforated with 6-piston fixed caliper
- Rear axle: Brake discs measuring 360 x 26 mm, internally ventilated and perforated with 1-piston floating caliper
- Increased fade resistance and reduced thermal deformation of brake discs
- Red-painted brake calipers with “AMG” lettering



AMG Carbon Ceramic Braking System (B07)

Option price: \$X,XXX

6-piston front and 4-piston rear calipers

- Front axle: composite ceramic disc with a diameter of 402 x 39 mm, internally ventilated and perforated, with 6-piston fixed caliper
- Rear axle: integral brake disc with a diameter of 360 x 32 mm, internally ventilated, perforated and grooved with 4-piston fixed brake caliper
- 40% weight saving compared with standard brake discs
- Able to withstand extreme loads and heat
- Motorsport braking performance, very high fade resistance
- Bronze-painted brake calipers with “AMG Carbon Ceramic” lettering

Steering wheels



AMG Performance steering wheel in Nappa leather / DINAMICA (L6I)
Standard

- Features a flattened bottom section
- Grip is finished in DINAMICA microfiber
- Silver-colored aluminum shift paddles
- 12-o'clock marking



AMG Performance steering wheel in Nappa leather (L6J)
Option Price: \$X,XXX

- Features a flattened bottom section
- Perforated grip areas
- Silver-colored aluminum shift paddles
- 12-o'clock marking.

LED Intelligent Light System (640)



LED Intelligent Light System (640)

Optional

- Excellent illumination of the road
- Integrated LED daytime running lamps with fiber optic effect
- Projector LED low-beam and reflective LED high-beam technology
- LED taillamps extending into tailgate
- Low energy consumption
- Color of emitted light more similar to that of daylight
- Much longer bulb life
- Automatic high-beam control by Adaptive Highbeam Assist
- Automatic adaptation of headlamps to weather, lighting and driving conditions for ideal visibility in every situation
- Automatically activated cornering lights
- Active light function for significantly better illumination in bends
- Distinctive look during day and night

AMG Performance seats (555)



AMG Performance Exhaust System (U78)

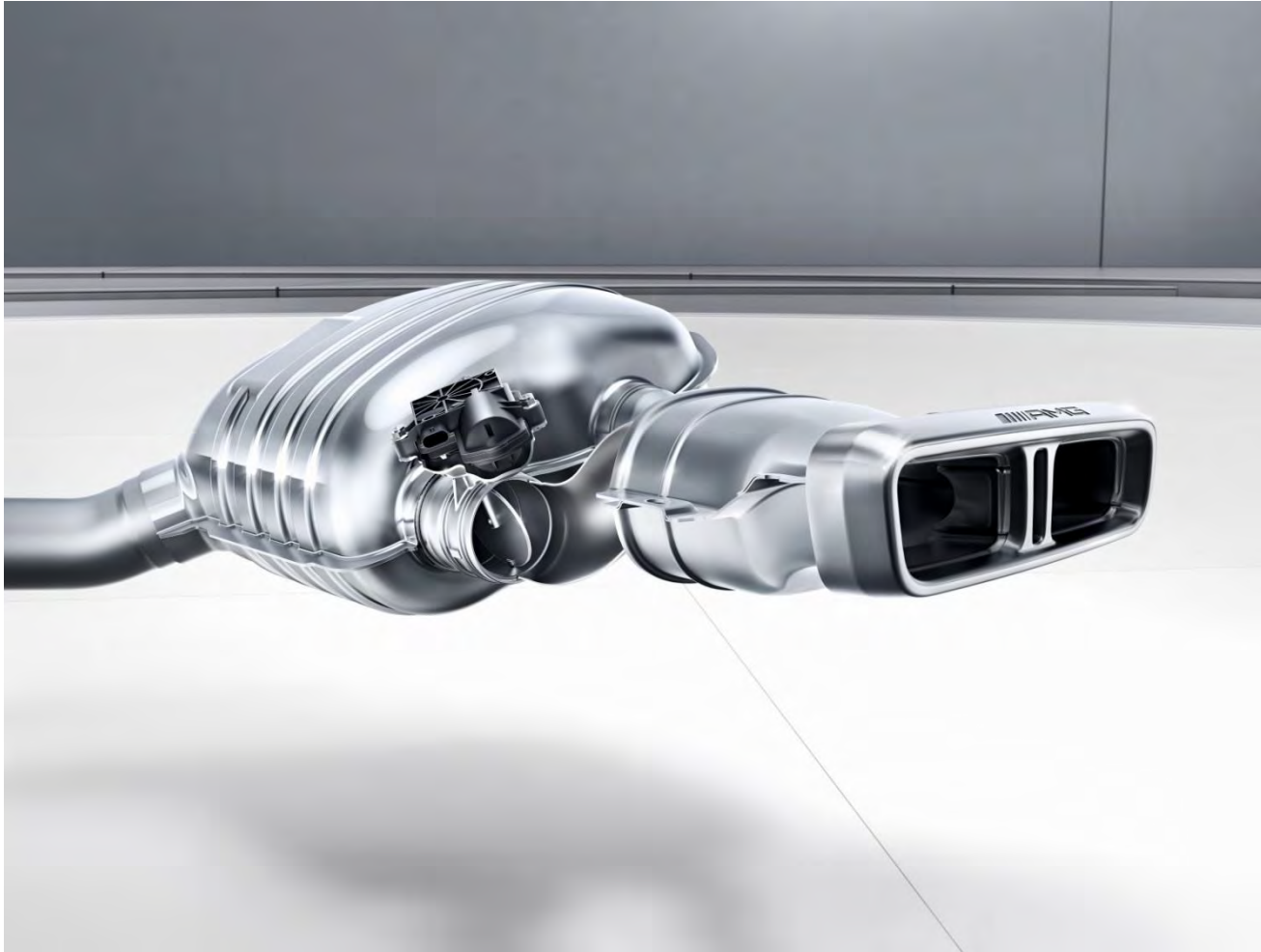

AMG performance exhaust system – strong sound optional

From typical AMG to restrained, the sound of the AMG performance exhaust system fully adapts to the currently selected transmission mode by means of three variably adjustable exhaust gas flaps. The driver can also change the sound characteristics at the press of a button. This optional equipment allows a maximum spread of the sound, from comfortable to highly emotive.

Two additional exhaust gas flaps allow for even greater differentiation of the sound characteristics. The sound characteristics are dependent on the currently selected drive program – from rich in drive programs C and S to emphatically sporty in drive programs S+ and Race. Control is by means of a variably adjustable exhaust gas flap – without loss of power. Control of the exhaust gas flaps is dependent on both engine speed and load, ensuring a 100% power delivery. If desired, the cold start noise can be reduced in drive programs C and S.

- Stronger differentiation of the sound characteristics by means of two additional exhaust gas flaps
- Sound characteristics dependent on selected drive program – clear differentiation between rich in drive programs C and S and emphatically sporty in drive programs S+ and Race (only for C 63 S)
- Additional control of the sound characteristics by means of a button in the middle control panel of the center console
- Control by means of variably adjustable exhaust gas flaps – without loss of power
- Control of the exhaust gas flaps is dependent on both engine speed and load, ensuring 100% power delivery
- Double declutching (in S) and a misfire (in S+ and Race emphasize the sporty characteristics of the particular drive programs

	<i>E 63 S</i>
Engine Configuration	Handcrafted AMG 4.0L V8 biturbo engine
Power (hp)	603
Torque (lb-ft)	627
Displacement (cc)	3,982
Acceleration 0-60 mph (sec)	3.4
Fuel Economy (Cty/Hwy/Comb)	TBD
Top Speed (mph)	180 (electronically limited)
Fuel Requirement (Octane)	91
# Valves per cylinder	4
Compression	8.6:1
Transmission	AMG SPEEDSHIFT MCT
Transmission Speeds	9
Drive Configuration	AMG Performance 4MATIC+ all-wheel drive with fully variable torque distribution
Fuel Tank Size (gallons)	21.1
Seating Capacity	5
Trunk Size (cubic feet)	35
Curb Weight (lbs)	TBD
Vehicle Length (in.)	197.1
Vehicle Width w/ exterior mirrors (in.)	81.3
Vehicle Height (in.)	58
Wheelbase (in.)	115.7
Track Width Front/Rear (in.)	64.9/62.8

